

 **Prosperplast**[®]
plastic products

Prosperplast 1 Sp. z o.o.
ul. Wilkowska 968
43-378 Rybarzowice | Poland



prosperplast.pl

Feel free to place your order via B2B

Nr BDO – 000015600

winter offer

PEAKSNOW

2022



OPEN



PEAKSNOW



Prosperplast®
plastic products

welcome



Rybarzowice – headquarter (production & warehouse)

At present Prosperplast is one of the leaders among the manufacturers of plastic products not only in Poland but also in Europe. The wide range of products contains articles for home and garden, such as pots, composters, palisades, watering cans, shovels, toolboxes and articles for children (sledges, slides, ride on cars, etc.). Prosperplast was founded in 1993 in Buczkowice, a village located in the south of Poland. Since beginning it is a family corporation. The present headquarters are situated in Rybarzowice (south of Poland) and the sale offices and warehouses are located also in Germany, Czech Republic and Hungary.

Rybarzowice – headquarter (production & warehouse)

Dziś firma Prosperplast jest jednym z liderów wśród producentów, nie tylko w Polsce, ale także w Europie szerokiej gamy artykułów z branży tworzyw sztucznych do domu i ogrodu, takich jak donice, kompostowniki, palisady, konewki, łopaty, skrzynki narzędziowe oraz artykuły dziecięce (sanki, ślizgi, autka, itd.). Prosperplast został założony w 1993 r. w Buczkowicach, miejscowości zlokalizowanej na południu Polski. Od samego początku jest to firma rodzinna. Obecnie siedziba znajduje się w Rybarzowicach (południe Polski), ponadto nasze biura handlowe i magazyny mieszczą się w Niemczech, Czechach oraz na Węgrzech.



Wilkowice – logistic centre

In its origins the company was producing only plastic pots. However, in response to market needs and growing expectations of the clients the range of products has grown in time by several lines of products, such as: snow shovels, children articles, DIY and household.



Wilkowice – logistic centre

W początkowym okresie działalności firma zajmowała się produkcją wyłącznie donic z tworzyw sztucznych. W odpowiedzi na potrzeby rynku i rosnące zainteresowanie ze strony klientów z upływem czasu asortyment poszerzył się o kolejne linie produktowe: łopaty do odśnieżania, artykuły dziecięce, asortyment DIY, a także artykuły gospodarstwa domowego.



Żywiec – production & warehouse

Owing to clever management and continuous investments in machinery, new designs and the crew the company expanded significantly between 2008-2021. Nowadays we have 4 production factories, multiple storage surfaces situated in 4 locations in Poland and logistic centers in Germany, Czech Republic and Hungary.

Prosperplast aims in continuous development, modernity and flexibility. Our products are known from their quality, original and diverse designs, thanks to that they are more and more popular, not only among the European clients, but also in USA, Australia, New Zealand or Republic of South Africa, South America, Africa and Japan.

More information about the company and products is available on our website www.prosperplast.pl



Buczkowice – production & warehouse

Dzięki racjonalnemu zarządzaniu i ustawicznym inwestycjom w maszyny, nowe wzornictwo, a także w załogę nastąpił dynamiczny rozwój firmy w latach 2008-2021. Obecnie dysponujemy czterema zakładami produkcyjnymi, powierzchniami magazynowymi zlokalizowanymi w czterech miastach w Polsce, a także centrum logistycznym w Niemczech, Czechach oraz na Węgrzech.

Prosperplast stawia na ciągły rozwój, nowoczesność i elastyczność, a nasze produkty cechuje doskonała jakość, oryginalne i zróżnicowane wzornictwo, dzięki czemu nasze towary cieszą się dużą i wciąż rosnącą popularnością nie tylko wśród klientów Europejskich, ale także w USA, Australii, Nowej Zelandii, Ameryki Południowej, Afryki i Japonii.

Więcej informacji o firmie i produktach na www.prosperplast.pl



Rybarzowice – showroom

showroom

Po wielu miesiącach ciężkiej pracy, mamy przyjemność zaprosić Państwa do odwiedzenia naszej nowej ekspozycji – ponad 400 m² pełnych nowych produktów, pomysłów i inspiracji. Nasi styliści stworzyli nowoczesne i minimalistyczne wnętrze z dedykowaną przestrzenią dla różnych kategorii produktowych. Szeroki wachlarz produktów oraz różnorodność zapewni stały rozwój Twojej firmie, o co w przyjemnej atmosferze zadba nasz profesjonalny zespół. Zapraszamy!

After months of hard work, we are really proud to invite you to visit our new Showroom – over 400 m² full of ideas, products and inspirations. Our stylists have created a modern and minimalist interior with designed space for all the product categories. Our wide range of assortment and its variety ensures a constant growth for you and your customers – our professional team takes care of everything! We can't wait to welcome you here!



recycling

environmental
protection
& economic aspects



Setki nowych drzew – świerków i buków rozpoczęło nowe, leśne życie. To efekt naszej akcji, która w porozumieniu z bielskim nadleśnictwem uzupełniła drzewostan Skrzycznego. Wierzymy, że podobnie jak sam Prosperplast jeszcze długo będą służyły pokoleniom, które przyjdą po nas.

Hundreds of new trees – spruces and beeches have begun their new forest life. This is the result of our action, thanks to which, in agreement with the forest inspectorate in Bielsko-Biała, the tree stand of Skrzyczne has been replenished. We believe that like Prosperplast itself they will serve generations to come after us for a long time.

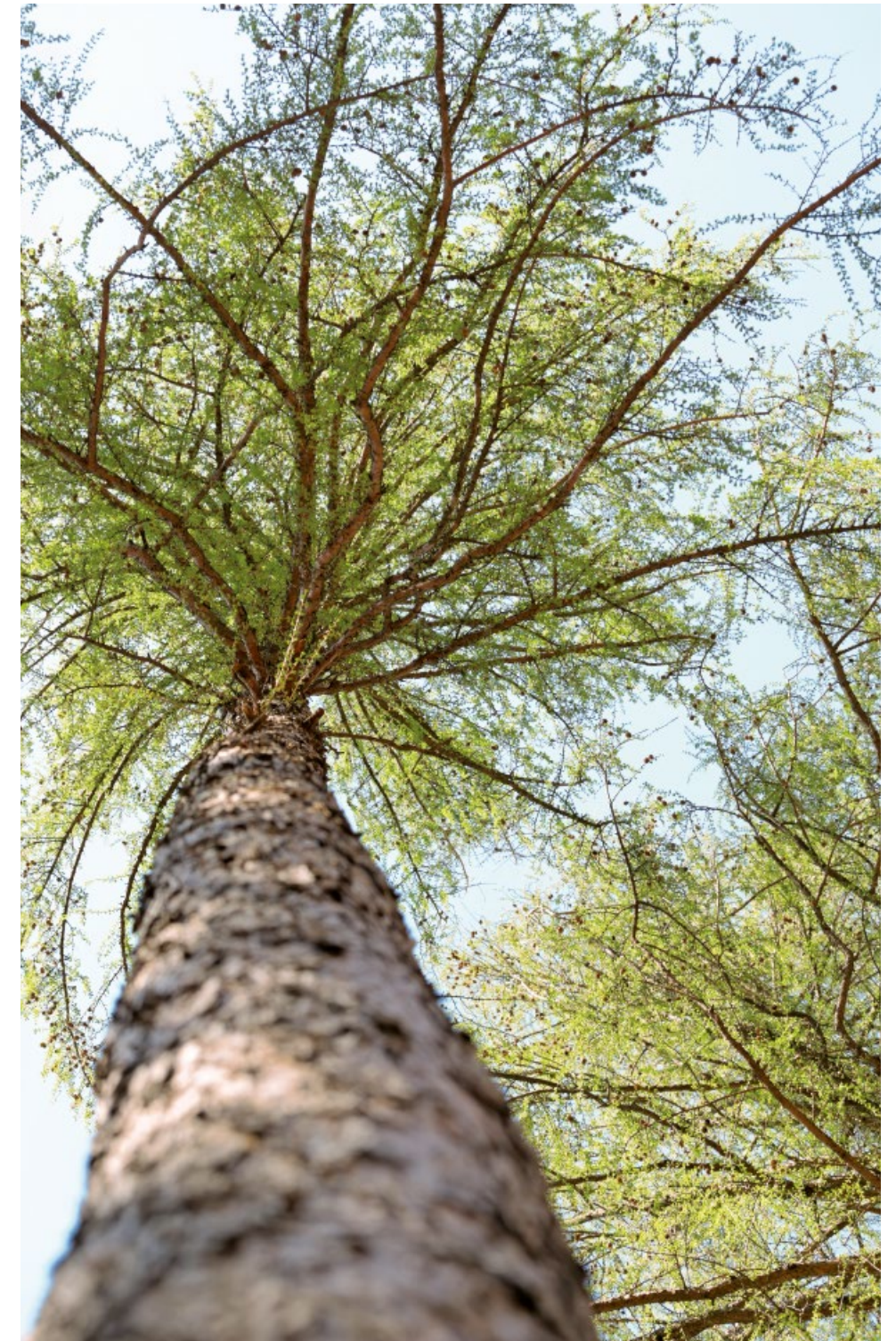

Produkcja, której surowcem jest plastik (np. pod postacią polipropylenu), to wbrew obiegowej opinii technologia przyjazna środowisku. Kiedy w grę wchodzi nowoczesne, wydajne maszyny, kiedy zużycie wody jest w całym procesie produkcji stosunkowo niskie, możemy śmiało powiedzieć, że DBAMY O ŚRODOWISKO. Jest z resztą więcej płaszczyzn, na których możemy realizować ten postulat. Stale powiększa się paleta produktów z serii ECO, wytwarzanych z surowców wtórnych. Sposób pakowania naszych produktów (UNIPACK-system – jeden idealnie wchodzi w drugi) pozwala na przewożenie dużych ilości jednym samochodem. To często wielokrotnie redukuje ilość spalin w powietrzu.

Production that uses plastic as raw material (such as polypropylene) is, despite what many believe, an environmentally friendly technology. When it comes to modern, efficient machines, and when water consumption in the whole process is relatively low, we can definitely say that we CARE about the ENVIRONMENT. In fact, there are more fields in which we can implement this postulate. We are constantly expanding the product range of ECO series, produced from recycled materials. The way we pack our products (usually one packaging fits perfectly into another) allows us transporting large volumes in one vehicle. This often causes a multiple reduction of the amount of exhaust gas in the atmosphere.

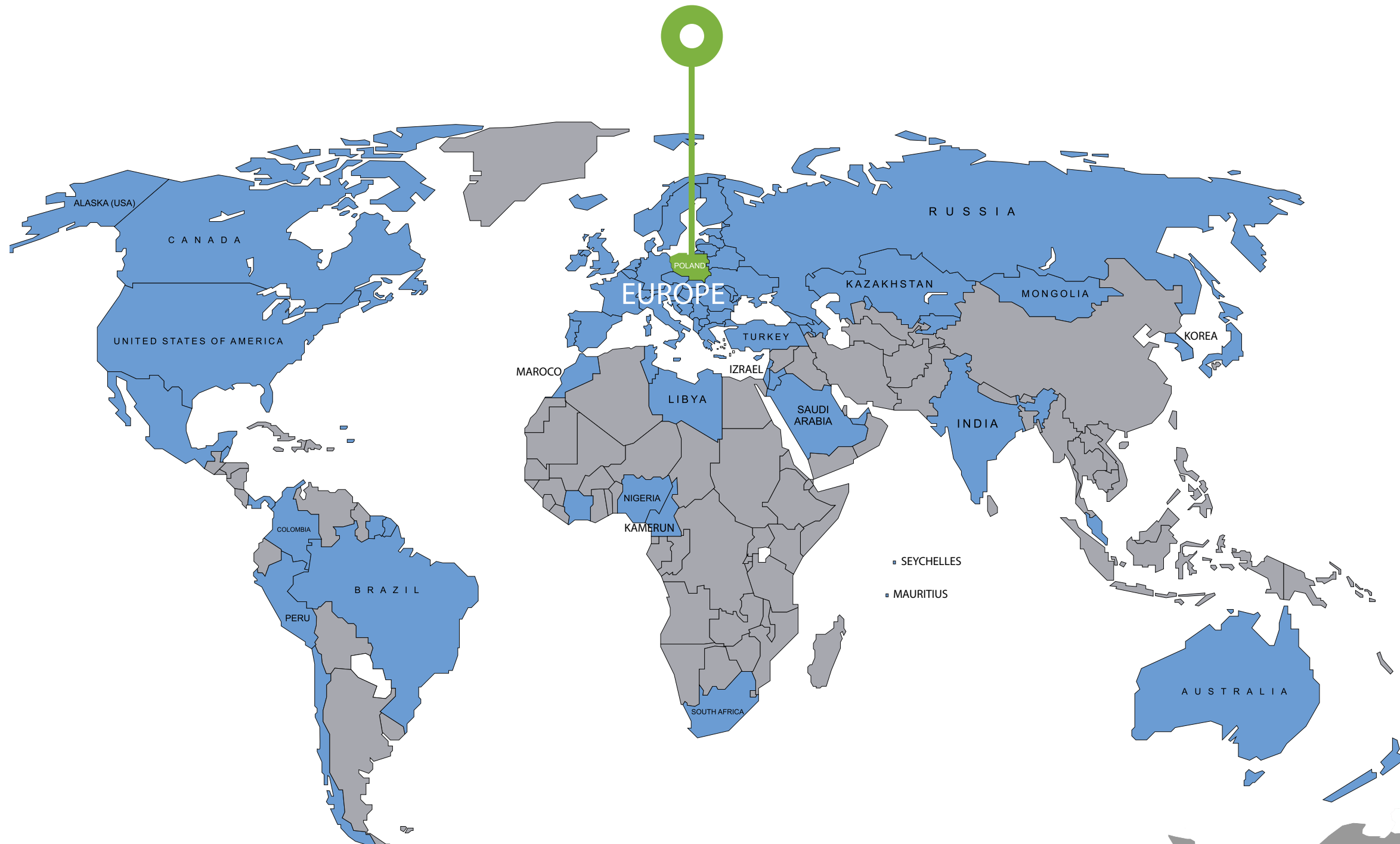

Prosperplast in the world

Constantly launching an innovative, diversified and high quality products and being a reliable partner, we managed to succeed on the market in different parts of the world.

Currently our products are successfully distributed to more than 80 countries worldwide and the number of satisfied customers is increasing each year!

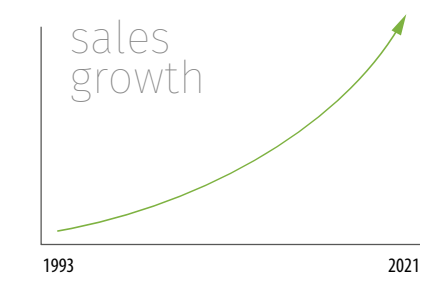

over 80 countries worldwide

































- Warehouse**
Prosperplast Deutschland GmbH
Weststrasse 6
02708 Löbau
Deutschland
- Warehouse**
Prosperplast 1 Sp. z o. o.
43-365 Wilkowice, ul. E. Kwiatkowskiego 23, Polska
- Warehouse**
Prosperplast 1 Sp. z o. o.
43-378 Rybarzowice, ul. Wilkowska 12, Polska
- Headquarter, production & warehouse**
Prosperplast 1 Sp. z o. o.
43-378 Rybarzowice, ul. Wilkowska 968, Polska
- Production & warehouse**
Prosperplast 1 Sp. z o. o.
34-300 Żywiec, ul. Leśnianka 81, Polska
- Production & warehouse**
Prosperplast 1 Sp. z o. o.
43-374 Buczkowice, ul. Wczasowa 733A, Polska
- Office**
Prosperplast s.r.o.
V Zátíši 810/1, 709 00 Ostrava - Mariánské Hory
Czech Republic
- Office**
Prosperplast Kft.
1136-H Budapest, Tátra u. 5/a, alagsor 2.
Magyarország
- Warehouse**
Prosperplast s.r.o.
Nošovice 330, 739 51 Nošovice, Czech Republic

index regular offer













PREMIUM

 new SNOW MOVER p. 18	 new SNOWER 40 ALUTUBE p. 23	 new SNOWER 40 PROFI p. 24	 new SNOWER 40 PROFI ERGO p. 25	 new SNOWER 50 ALUTUBE p. 27
 new SNOWER 50 PROFI p. 28	 new SNOWER 50 PROFI ERGO p. 29	 new SNOWER 55 ALUTUBE p. 31	 new SNOWER 55 PROFI p. 32	 new SNOWER 55 PROFI ERGO p. 33
 new SNOWER 55D ALUTUBE p. 35	 new SNOWER 55D PROFI p. 36	 new SNOWER 55D PROFI ERGO p. 37	 new RAKE LOADER p. 38	 DIABLO p. 39
 ERGOSPECIAL p. 39	 SNOW MONSTER p. 40	 MAKALU p. 42	 ALUEDGE p. 43	 ALUEDGE ERGO p. 43
 ALUMAX p. 44	 ALUMAX S p. 44	 ALUMAX ERGO p. 45		

 NANGA CAR TELESCOPIC p. 52	 EVEREST p. 53	 LHOTSE p. 53	 SNOW RIDER 1 p. 54	 ARCTIC p. 54	 ARCTIC L p. 55
 ARCTIC XL p. 55	 STRONGMAN 60 p. 56	 STRONGMAN 80 p. 56	 ALUICE 40 p. 58	 ALUICE 50 p. 58	 ALUICE 50 P p. 59
 SKANDYNAWIA 2 p. 59	 ICE 1 p. 60	 ICE 2 p. 60	 ICE 3 p. 61	 SHARKIE p. 61	 KAJ p. 62
 GERDA p. 62	 ALASKA p. 63	 ALASKA p. 63	 FROST p. 64	 ICE CAR 1 p. 64	 ICE CAR 2 p. 65
 BOBO p. 66	 IGLOO COMFORT p. 66	 IGLOO COMFORT ALU p. 67	 LOAD BABY p. 67	 LOAD BABY ALU p. 68	 FOCUS BABY p. 68



STANDARD RANGE

 ALPIN 1 A p. 47	 ALPIN 2 A p. 47	 ALPIN 2 METAL p. 48	 ALPIN 2 ALUTUBE p. 48	 ALPINUS METAL p. 49
 ALPINUS ALUTUBE p. 49	 ALPINUS ALUTUBE ERGO p. 50	 ERGOMETAL p. 50	 ALPE 50 TELESCOPIC p. 51	 STANDARD 1 p. 51
 STANDARD 2 p. 52				



BASIC RANGE

 PRACTIC ECO p. 71	 NONAME 41 ECO p. 71	 NONAME 47 ECO p. 72	 ALPINUS ECO p. 72	 ALPIN ALUTUBE ECO p. 73
 ALPINUS ALUTUBE ECO p. 73	 ALPE 50 ECO TELESCOPIC p. 74	 NANGA ECO CAR TELESCOPIC p. 74	 EVEREST ECO p. 75	 ARCTIC ECO p. 76
 ARCTIC L ECO p. 76				

ASK FOR MOQ special order



BASIC RANGE

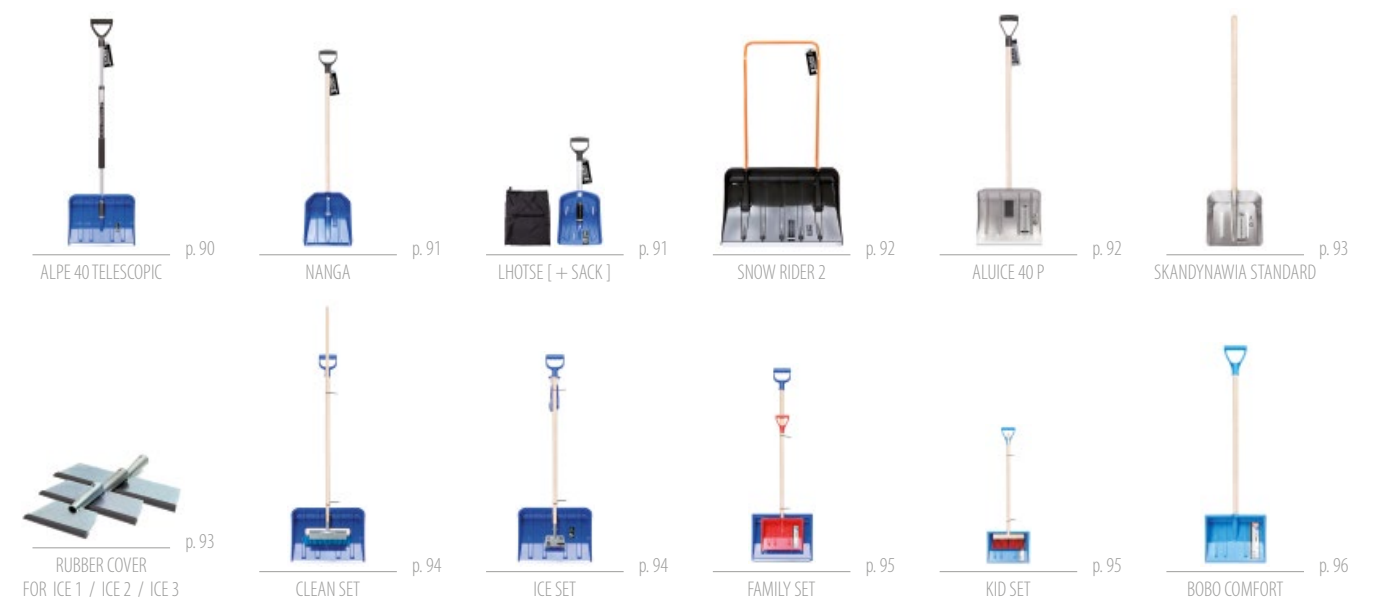

STANDARD RANGE



PREMIUM



SNOW MOVER
snow blower

ILSM600
S411 5905197369334
not assembled 30
not assembled 990

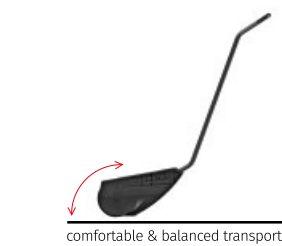

new



easiest way
to remove snow



click
system

Najbardziej ekologiczna opcja dostępna na rynku!
Ręczny płóg do śniegu wyposażony w ślimakowy przenośnik wyrzucający śnieg na prawą stronę, co znacznie przyspiesza proces odśnieżania dużych powierzchni, również na terenie obiektów przemysłowych. Krawędź natarcia zabezpieczona aluminiowym okuciem. System połączenia sztyła z łyżką zgarniacza ułatwia montaż dla celów użytkowania i przechowywania. Mrozoodporny.

*The most eco-friendly option available on the market!
A hand powered manual snow blower shovel equipped with an auger that throws snow aside, which significantly speeds up snow removal from driveway and large areas, including industrial facilities. The blade is reinforced with aluminum edge. Click on/off connection system is a perfect solution for comfortable use and storage. Frostresistant.*

PEAKSNOW



series

PREMIUM

PROFESSIONAL SHOVELS



STRONG



DURABLE



FLEXIBLE



THERMO-STOP



4 SEASONS



PUSH & UNLOAD

COMPONENTS

two-position locking connector which ensuring easy assembly for use and disassembly for storage

reinforced construction

shaft tip

wide working edge protected with aluminum edge

deep blade



Cenione przez użytkowników technicznie zaawansowane, profesjonalne i bardzo wytrzymałe narzędzia na długie lata. Wypróbowane w trudnych warunkach, trwałe i odporne.

Wysokie parametry użytkowe i ergonomiczne, konstrukcja dopracowana pod kątem wytrzymałości, wydajności i uniwersalności zastosowań. Zastosowane innowacyjne rozwiązania zapewniają bardzo wysoką ergonomię i komfort pracy.

Valued by users these technically advanced, professional and very durable tools will last you for many years to come. The rage has been tried in extreme conditions and proved to be durable and resistant for weather conditions.

Their high performance and ergonomic design, manufacture with consistency and attention to details make them required by the professionals and every day users. The innovative solutions used in design and manufacturing will ensure very high ergonomic and comfort at work.

two-component D-grip IU-14

aluminum handle

rubber athermal cover

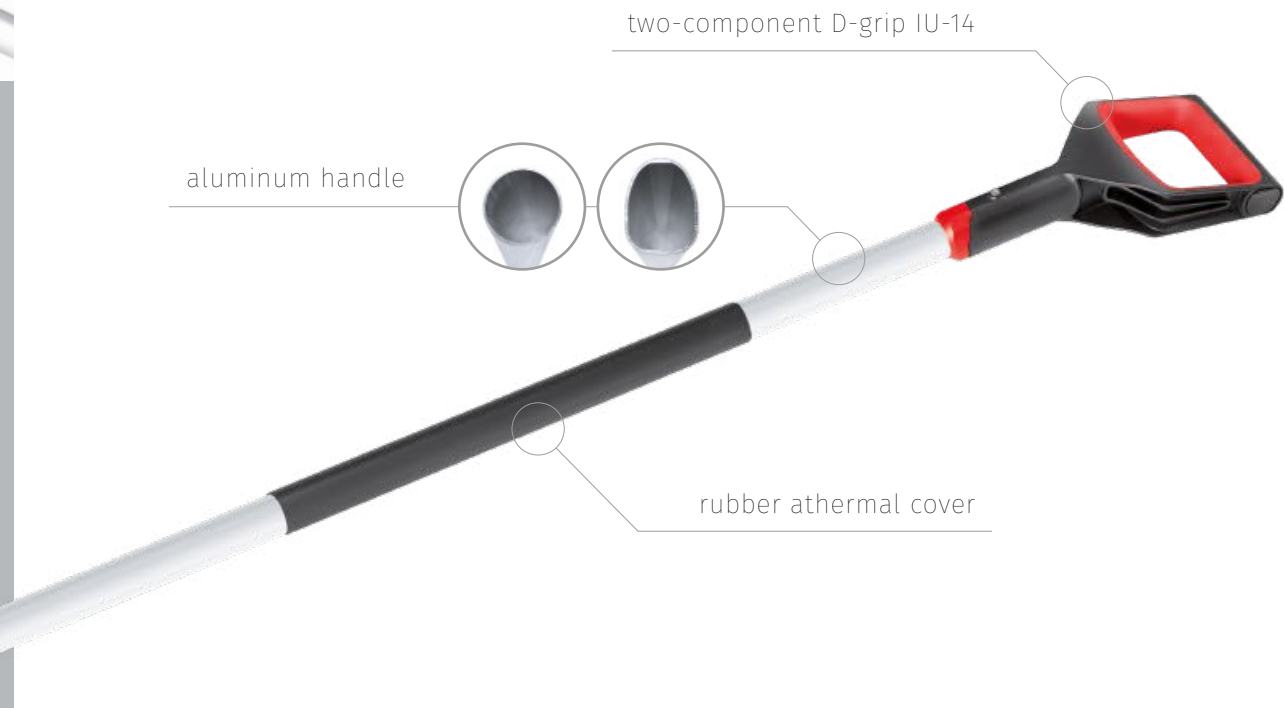

twist-lock system





SNOWER 40

Wytrzymała wielozadaniowa łopata do całorocznych zastosowań, o świetnych parametrach technicznych, wyposażona w wygodną dwukomponentową rączkę. Krawędź natarcia zabezpieczona aluminium okuciem. Mrozoodporna. Zastosowano innowacyjny system połączenia sztyła z korpusem łopaty za pomocą obrotowego 2-biegunowego (dwupozycyjnego) łącznika blokującego, zapewniający łatwy montaż dla celów użytkowania i demontaż na czas przechowywania.

Durable multi-purpose shovel for all season purposes with excellent technical parameters, equipped with a 2-component convenient handle. The working edge is reinforced with an aluminum ferrule. Frost resistant. An innovative system of connecting the shovel with the blade using a rotating, 2 (two-position) locking connector which ensuring easy assembly for use and disassembly for storage.

new



SNOWER 40 ALUTUBE professional snow shovel

	IAR40TB
	R444 5905197222257
	not assembled 300 200
	assembled 60
	not assembled 4200 4200
	assembled 1920



ergonomic two-component D-grip IU-14















TOTAL 1340 mm

354 mm

SNOWER 40 PROFI













professional snow shovel

	IAR40LXP
	R444 5905197222288
	not assembled  300  200
	assembled  60
	not assembled  4200  4200
	assembled  1920



SNOWER 40 PROFI ERGO

professional snow shovel

	IAR40EP
	R444 5905197222271
	not assembled  300  200
	assembled  60
	not assembled  4200  4200
	assembled  1920





SNOWER 50

Profesjonalna, wytrzymała łopata do odśnieżania, o świetnych parametrach technicznych i szerokiej krawędzi natarcia, zabezpieczonej aluminium okuciem. Wyposażona w wygodną dwukomponentową rączkę. Mrozoodporna. Zastosowano innowacyjny system połączenia sztyła z korpusem łopaty za pomocą obrotowego 2-biegunowego (dwupozycyjnego) łącznika blokującego, zapewniający łatwy montaż dla celów użytkowania i demontaż na czas przechowywania.

A professional, durable snow shovel with excellent technical parameters and a wide working edge protected with an aluminum ferrule. Equipped with a comfortable 2-component handle. Frost resistant. An innovative system of connecting the shovel with the blade using a rotating, 2 (two-position) locking connector which ensuring easy assembly for use and disassembly for storage.

new



SNOWER 50 ALUTUBE professional snow shovel

	IAR50TB
	R444 5905197222301
	not assembled 240 200
	assembled 50
	not assembled 3600 3600
	assembled 1600



ergonomic two-component D-grip IU-14

aluminium handle Ø 30 mm
rubber athermal cover

uni-pack system

permanent fix
once click

aluminium
edge



497 mm

82 mm

TOTAL 1320 mm

346 mm

SNOWER 50 PROFI

professional snow shovel

	IAR50LXP
	R444 5905197222332
	not assembled 240 200
	assembled 50
	not assembled 3600 3600
	assembled 1600



SNOWER 50 PROFI ERGO

professional snow shovel

	IAR50EP
	R444 5905197222325
	not assembled 240 200
	assembled 50
	not assembled 3600 3600
	assembled 1600





SNOWER 55

Niezawodna, wydajna łopata do odśnieżania, o wzmocnionej konstrukcji, wytrzymałej silny nacisk i szerokiej krawędzi natarcia, zabezpieczonej aluminium okuciem. Wyposażona w wygodną dwukomponentową rączkę. Mrozoodporna. Zastosowano innowacyjny system połączenia sztyła z korpusem łopaty za pomocą obrotowego 2-biegunowego (dwupozycyjnego) łącznika blokującego, zapewniający łatwy montaż dla celów użytkowania i demontaż na czas przechowywania.

Reliable, efficient snow shovel with reinforced structure that withstands strong pressure and a wide working edge protected with aluminum ferrule. Equipped with a comfortable 2-component handle. Frost resistant. An innovative system of connecting the shovel with the blade using a rotating, 2 (two-position) locking connector which ensuring easy assembly for use and disassembly for storage.

new



PEAKSNOW



SNOWER 55 ALUTUBE

professional snow shovel

	IAR55TB
	R444 5905197222356
	not assembled 240 200
	assembled 50
	not assembled 3600 3600
	assembled 1600



ergonomic two-component D-grip IU-14

aluminium handle Ø 30 mm
rubber athermal cover

uni-pack system

permanent fix once click

aluminium edge

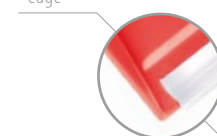

545 mm

89 mm

TOTAL 1360 mm

385 mm

SNOWER 55 PROFI

professional snow shovel

	IAR55LXP
	R444 5905197222387
	not assembled 240 200
	assembled 50
	not assembled 3600 3600
	assembled 1600



SNOWER 55 PROFI ERGO

professional snow shovel

	IAR55EP
	R444 5905197222370
	not assembled 240 200
	assembled 50
	not assembled 3600 3600
	assembled 1600





SNOWER 55D

Bezkonkurencyjne, bardzo pojemne narzędzie do zadań specjalnych, o wzmocnionej konstrukcji, wytrzymałej silny nacisk i szerokiej krawędzi natarcia, zabezpieczonej aluminiowym okuciem. Wyposażona w wygodną dwukomponentową rączkę. Mrozoodporna. Zastosowano innowacyjny system połączenia sztyła z korpusem łopaty za pomocą obrotowego 2-biegunowego (dwupozycyjnego) łącznika blokującego, zapewniający łatwy montaż dla celów użytkowania i demontaż na czas przechowywania.

An unique, very capacious tool for special tasks with a reinforced structure that withstands strong pressure and a wide leading edge protected with an aluminum ferrule. Equipped with a comfortable 2-component handle. Frost resistant. An innovative system of connecting the shovel with the blade using a rotating, 2 (two-position) locking connector which ensuring easy assembly for use and disassembly for storage.

new



PEAKSNOW



SNOWER 55D ALUTUBE

professional snow shovel

	IARG55TB
	R444 5905197222400
	not assembled 160 200
	assembled 50
	not assembled 3040 3040
	assembled 1600



ergonomic two-component D-grip IU-14



SNOWER 55D PROFI

professional snow shovel

	IARG55LXP
	R444 5905197222431
	not assembled
	assembled
	not assembled
	assembled



SNOWER 55D PROFI ERGO

professional snow shovel

	IARG55EP
	R444 5905197222424
	not assembled
	assembled
	not assembled
	assembled



RAKE LOADER

spade-rake / special task-tool 2in1

ILG2		
S411	5905197267654	
not assembled	300	200
assembled	60	
not assembled	4200	4200
assembled	1920	



new



385 mm

145 mm

TOTAL 1460 mm

380 mm

DIABLO

professional shovel

ILD8		
R444	5905197141596	
not assembled	160	300
assembled	70	
not assembled	3360	3360
assembled	2240	



ERGOSPECIAL

professional shovel

ILEX55		
B333	5905197141695	
not assembled	160	320
assembled	70	
not assembled	3520	3520
assembled	2240	



520 mm

135 mm

TOTAL 1550 mm

395 mm



550 mm

120 mm

TOTAL 1535 mm

380 mm

SNOW MONSTER
professional pusher

ILMON	
S411	5905197142302
assembled	20
assembled	660



easy to assemble
& disassemble

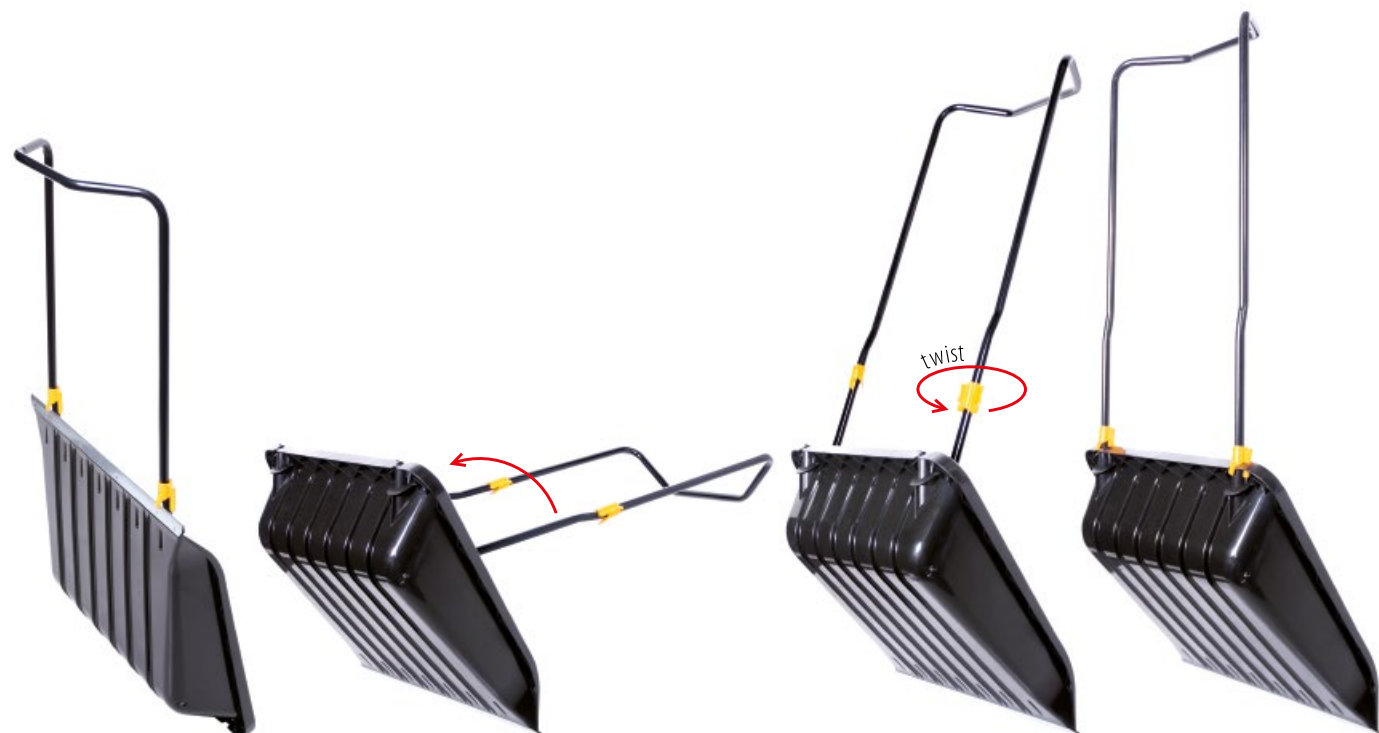

lock
system



Bardzo wytrzymały wydajny zgarniacz do większych zastosowań, sprawdzający się przy odśnieżaniu dużych powierzchni, również na terenie obiektów przemysłowych. Zastosowano innowacyjne połączenie sztyla z tyłką zgarniacza, ułatwiające montaż dla celów użytkowania i przechowywania. Krawędź natarcia zabezpieczona aluminium okuciem. Mrozoodporny.

A heavy duty, effective pusher for snow removal from larger areas including industrial facilities. An innovative connection of a shaft and blade make it a perfect solution for usage comfort and storage. The blade is reinforced with aluminum edge. Frost resistant.

MAKALU
car shovel

ILSN1
CPNO 5905197140438
assembled 120
assembled 7920



ALUEDGE
aluminium shovel

ILEGM
ALU 5905197142241
assembled 80
assembled 2640



ALUEDGE ERGO
aluminium shovel

ILEDE
ALU 5905197142258
assembled 80
assembled 2640





ALUMAX
aluminium shovel

	ILMAXA
	ALU 5905197141541
	assembled 80
	assembled 2640



ALUMAX ERGO
aluminium shovel

	ILMAXAE
	ALU 5905197142135
	assembled 80
	assembled 2640



ALUMAX S
aluminium shovel

	ILMAXS
	ALU 5905197141558
	assembled 80
	assembled 2640





series

STANDARD RANGE

SHOVELS & ACCESSORIES



- STRONG
- DURABLE
- FLEXIBLE
- THERMO-STOP
- 4 SEASONS
- PUSH & UNLOAD

COMPONENTS

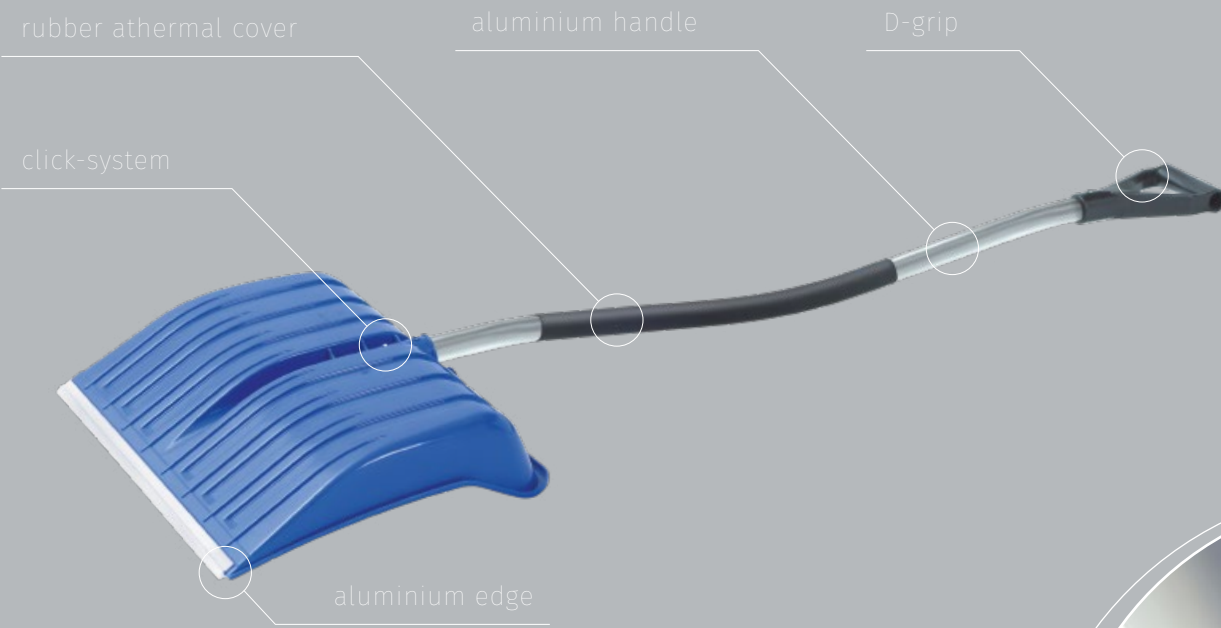

Niezawodne, mrozooodporne, wielozadaniowe narzędzia, wypróbowane w każdych warunkach. Wysokie parametry użytkowe i ergonomiczne, konstrukcja dopracowana pod kątem wytrzymałości, wydajności i uniwersalności zastosowań.

Frost-resistant, multi-purpose tools ensure their durability and reliability in all condition. Their high performance and ergonomic design, manufacture with consistency and attention to details make them required by the professionals and every day users.

click system



ALPIN 1 A snow shovel

	IL1A
	8333 5905197140537
	not assembled 360 1440
	assembled 160
	not assembled 8640 8640
	assembled 5280

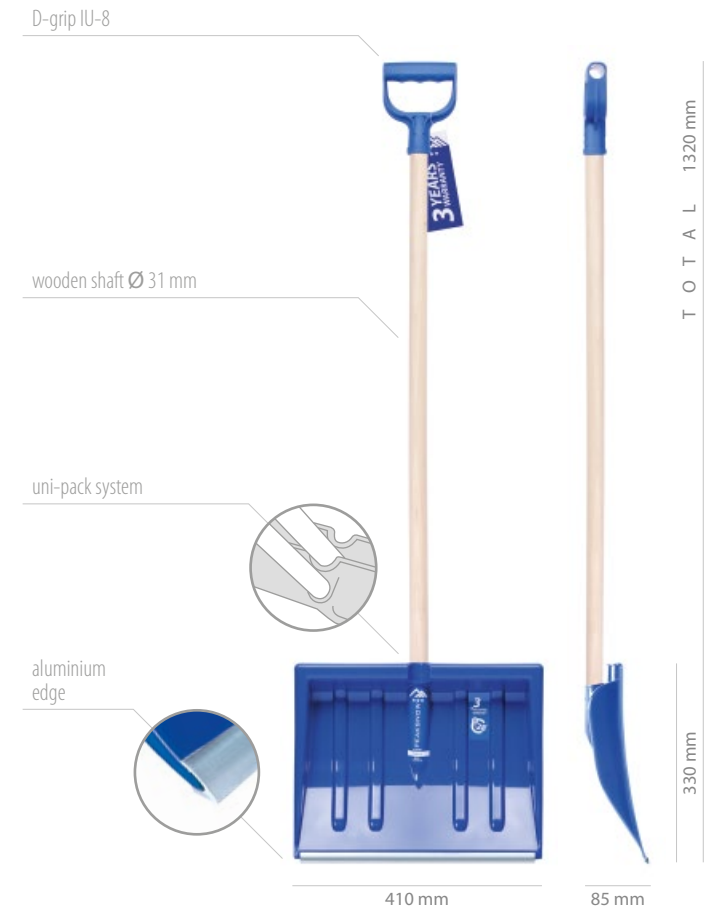

ALPIN 2 A snow shovel

	IL2A
	8333 5905197140544
	not assembled 300 1440
	assembled 100
	not assembled 7500 7500
	assembled 3300

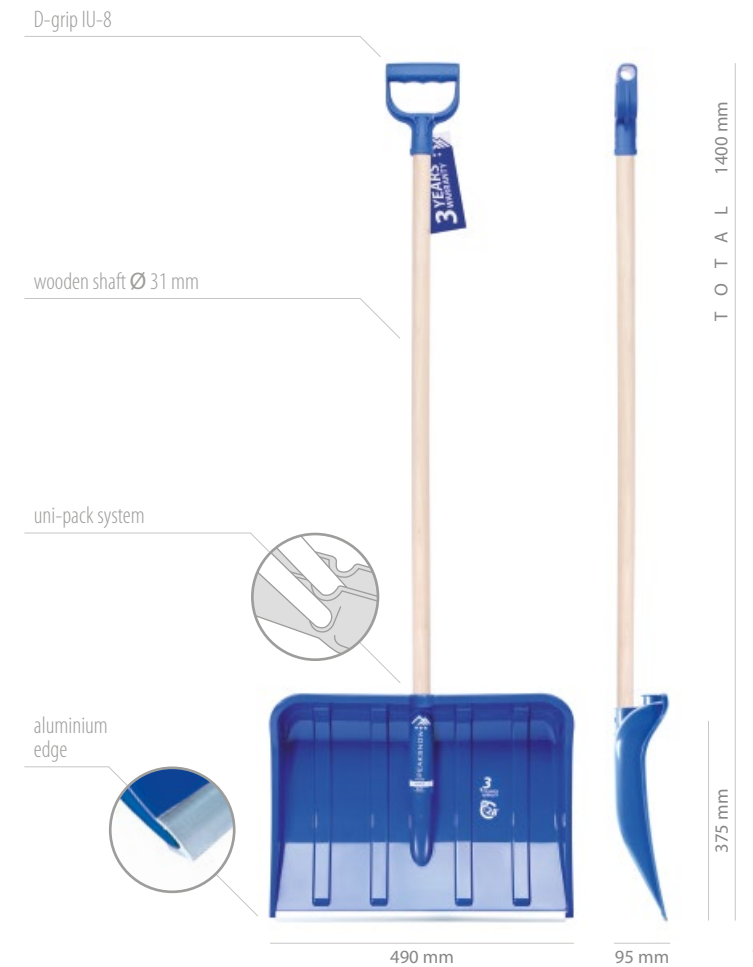



ALPIN 2 METAL snow shovel

	IL2AMT
	B333 5905197141213
	not assembled 300 350
	assembled 75
	not assembled 5400 5400
	assembled 2475



ALPINUS METAL snow shovel

	IL3MTA
	B333 5905197141268
	not assembled 160 350
	assembled 70
	not assembled 3680 3680
	assembled 2240



ALPIN 2 ALUTUBE snow shovel

	IL2TB
	B333 5905197141237
	not assembled 300 350
	assembled 100
	not assembled 5400 5400
	assembled 3300



ALPINUS ALUTUBE snow shovel

	IL3TB
	B333 5905197141275
	not assembled 160 350
	assembled 70
	not assembled 3680 3680
	assembled 2240





ALPINUS ALUTUBE ERGO snow shovel

IL3TBE		
B333	5905197441382	
not assembled	160	350
assembled	70	
not assembled	3680	3680
assembled	2240	



ALPE 50 TELESCOPIC snow shovel

IL50TSC		
B333	5905197142074	
not assembled	300	250
assembled	100	
not assembled	5400	5400
assembled	3300	



ERGOMETAL snow shovel

ILEFE		
B333	5905197141640	
not assembled	200	350
assembled	100	
not assembled	4200	4200
assembled	3300	



STANDARD 1 snow shovel

ILN1		
B333	5905197141725	
not assembled	240	1060
assembled	90	
not assembled	5760	5760
assembled	2970	





STANDARD 2 snow shovel

ILN2		
B333	5905197141732	
not assembled	160	1000
assembled	90	
not assembled	4160	4160
assembled	2970	



EVEREST car shovel

ILS1		
B333	5905197140551	
assembled	140	
assembled	9240	



NANGA CAR TELESCOPIC car shovel

ILNGTSC		
B333	5905197141435	
assembled	120	
assembled	7920	



LHOTSE car shovel

ILHOT		
B333	5905197141633	
assembled	120	
assembled	7920	



SNOW RIDER 1 pusher

	ILSR1	
	5905197097329	
	5905197094397	
	not assembled	+ 50
	assembled	30
	not assembled	+ 3300
	assembled	990



ARCTIC L pusher

	ILL	
	5905197141701	
	not assembled	100
	assembled	18
	not assembled	1600
	assembled	594



ARCTIC pusher

	ILB	
	5905197140575	
	not assembled	+ 50
	assembled	30
	not assembled	+ 3300
	assembled	990



ARCTIC XL pusher

	ILXL	
	5905197141718	
	not assembled	80
	assembled	15
	not assembled	1280
	assembled	495



PEAKSNOW



★★★★★
STANDARD

STRONGMAN 60

pusher

	ILZM60
	STEEL 5905197141398
	assembled 20
	assembled 660

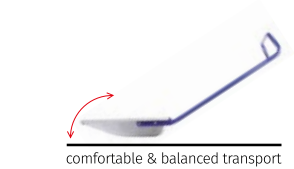

powder-coated metal handle Ø 25 mm



PEAKSNOW



★★★★★
STANDARD

STRONGMAN 80

pusher

	ILZM80
	STEEL 5905197141404
	assembled 12
	assembled 396



powder-coated metal handle Ø 25 mm





ALUICE 40

aluminium shovel

	ILAL40
	ALU 5905197141749
	not assembled 600 1500
	assembled 60
	not assembled 12000 12000
	assembled 1980



ALUICE 50 P

aluminium shovel

	ILALP5
	ALU 5905197141619
	not assembled 400 1000
	assembled 60
	not assembled 8000 8000
	assembled 1980



ALUICE 50

aluminium shovel

	ILAL50
	ALU 5905197141756
	not assembled 600 1500
	assembled 60
	not assembled 12000 12000
	assembled 1980



SKANDYNAWIA 2

aluminium shovel

	ILSK2
	ALU 5905197140506
	not assembled 600 1060
	assembled 80
	not assembled 12000 12000
	assembled 2640





ICE 1 ice hammer

	ICE1
	STEEL 5905197199504
	assembled 600
	assembled 19800



ICE 3 ice hammer

	ICE3
	STEEL 5905197199481
	assembled 300
	assembled 9900



ICE 2 ice hammer

	ICE2
	STEEL 5905197199511
	assembled 600
	assembled 19800



SHARKIE multipurpose spreading shovel

	ISSS
	B333/S411 5905197199542
	G642/S411 5905197067070
	assembled 960
	assembled 31680

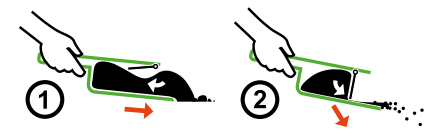

KAJ

ice scraper

	IZS1
	MIX 5905197190303
	B333 R444 116C G800 S411
	assembled 24000
	assembled 792000



ALASKA

ice scraper

	IZS3
	MIX 5905197190327
	B333 R444 116C G800 S411
	assembled 9600
	assembled 316800



GERDA

ice scraper

	IZS2
	MIX 5905197190310
	B333 R444 116C G800 S411
	assembled 7680
	assembled 253440



ALASKA PLUS

ice scraper

	IZS3A
	MIX 5905197190334
	B333 R444 116C G800 S411
	assembled 2880
	assembled 95040



FROST

ice scraper

	IZS4
	MIX 5905197190341
	B333 R444 116C G800 S411
	assembled 9600
	assembled 316800



ICE CAR 2

folding set 2in1 – snow & ice

	IZCAR2
	MIX 5905197190419
	B333/S411 R444/S411 116C/S411 G800/S411
	assembled 1440
	assembled 47520

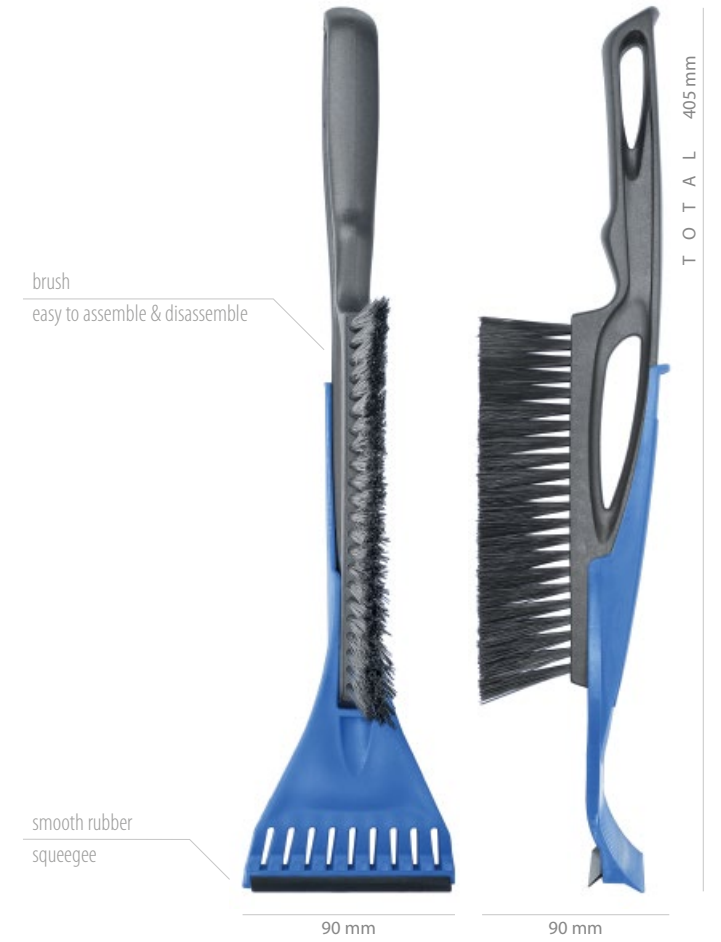

ICE CAR 1

ice scraper – snow & ice

	IZCAR1
	MIX 5905197190402
	B333 R444 116C G800
	assembled 1440
	assembled 47520



BOBO

multi-purpose shovel

	IL01
	3005U 5905197140452
	1788C 5905197095639
	205C 5905197096803
	not assembled 960 2000
	assembled 150
	not assembled 21120 21120
	assembled 9900



IGLOO COMFORT ALU

multi-purpose shovel

	ILM2A
	3005U 5905197140377
	assembled 150
	assembled 9900

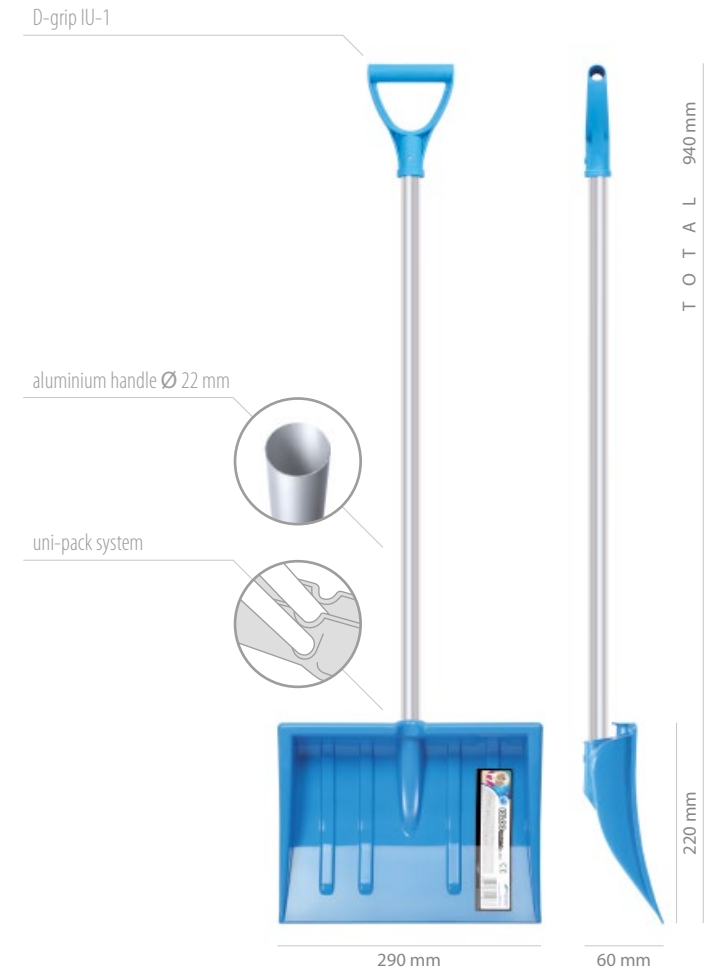

IGLOO COMFORT

multi-purpose shovel

	ILM2
	3005U 5905197140483
	1788C 5905197094069
	not assembled 840 2000
	assembled 150
	not assembled 19320 19320
	assembled 9900



LOAD BABY

multi-purpose shovel

	IBLD
	3005U 5905197979847
	1788C 5905197979830
	361C 5905197979854
	not assembled 1200 3600
	assembled 384
	not assembled 30000 30000
	assembled 12672



LOAD BABY ALU

multi-purpose shovel

	IBLA
	3005U 5905197979816
	1788C 5905197979809
	361C 5905197979823
	assembled
	assembled



FOCUS BABY

rake

	IBDG
	3005U 5905197979786
	1788C 5905197979779
	361C 5905197979793
	not assembled
	assembled
	not assembled
	assembled





series

BASIC RANGE

SHOVELS



- DURABLE
- FLEXIBLE
- 4 SEASONS
- THERMO-STOP
- MULTI-PURPOSE

Nasze produkty projektowane są w taki sposób, aby ich recykling był możliwy i jak najprostszy. Zaawansowana technologia przetwarzania własnych tworzyw sztucznych pozwala na ponowne wykorzystanie powstałego surowca jako głównego składnika tworzywa. Narzędzia z serii BASIC RANGE potwierdzają, że produkty pochodzące z recyklingu są tak samo niezawodne, skuteczne oraz atrakcyjne wizualnie, jak artykuły wykonane z pierwotnego surowca.

Our products are designed in a way to reach the highest example of recent inventions in the world of plastic recycling and sustainability. The advanced technology of re-processing our materials allows us to reuse the material as the main component in any next production. BASIC Range is the best proof and confirms that products from recycling are just as reliable, effective and visually appealing as articles made of the original raw material.

zero waste
circular economy

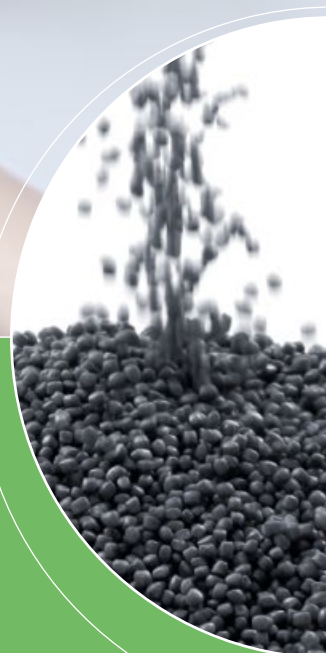

PRACTIC ECO

snow shovel

	ILT37
	S411 5905197141312
	not assembled 480 1440
	assembled 160
	not assembled 10560 10560
	assembled 5280



NONAME 41 ECO

snow shovel

	ILT41
	S411 5905197141763
	not assembled 360 1440
	assembled 160
	not assembled 8640 8640
	assembled 5282





NONAME 47 ECO

snow shovel

	ILT47
	S411 5905197141770
	not assembled 300 1440
	assembled 100
	not assembled 7500 7500
	assembled 3300



ALPIN ALUTUBE ECO

snow shovel

	ILT2TB
	S411 5905197141343
	not assembled 300 350
	assembled 100
	not assembled 5400 5400
	assembled 3300



ALPINUS ECO

snow shovel

	ILT55
	S411 5905197141329
	not assembled 160 1440
	assembled 70
	not assembled 4480 4480
	assembled 2240



ALPINUS ALUTUBE ECO

snow shovel

	ILT3TB
	S411 5905197141350
	not assembled 160 350
	assembled 70
	not assembled 3680 3680
	assembled 2240





ALPE 50 ECO TELESCOPIC snow shovel

	ILT50TSC
	S411 5905197141473
	not assembled 300 250
	assembled 100
	not assembled 5400 5400
	assembled 3300



EVEREST ECO car shovel

	ILTEV
	S411 5905197141336
	assembled 140
	assembled 9240



NANGA ECO CAR TELESCOPIC car shovel

	ILTNGTSC
	S411 5905197141992
	assembled 120
	assembled 7920





ARCTIC ECO pusher

	ILTB
	S411 5905197141367
	not assembled + 50
	assembled 30
	not assembled + 3300
	assembled 990

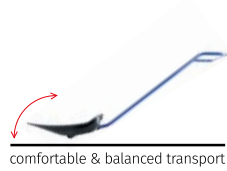

ARCTIC L ECO pusher

	ILTL
	S411 5905197141374
	not assembled 100 100
	assembled 18
	not assembled 1600 1600
	assembled 594



ASK FOR MOQ

YOUR OWN COMPOSITION OF VARIOUS
COLOURS & CUSTOMIZED FUNCTIONALITY

offer

SPECIAL ORDER



C
O
M
P
O
N
E
N
T
S

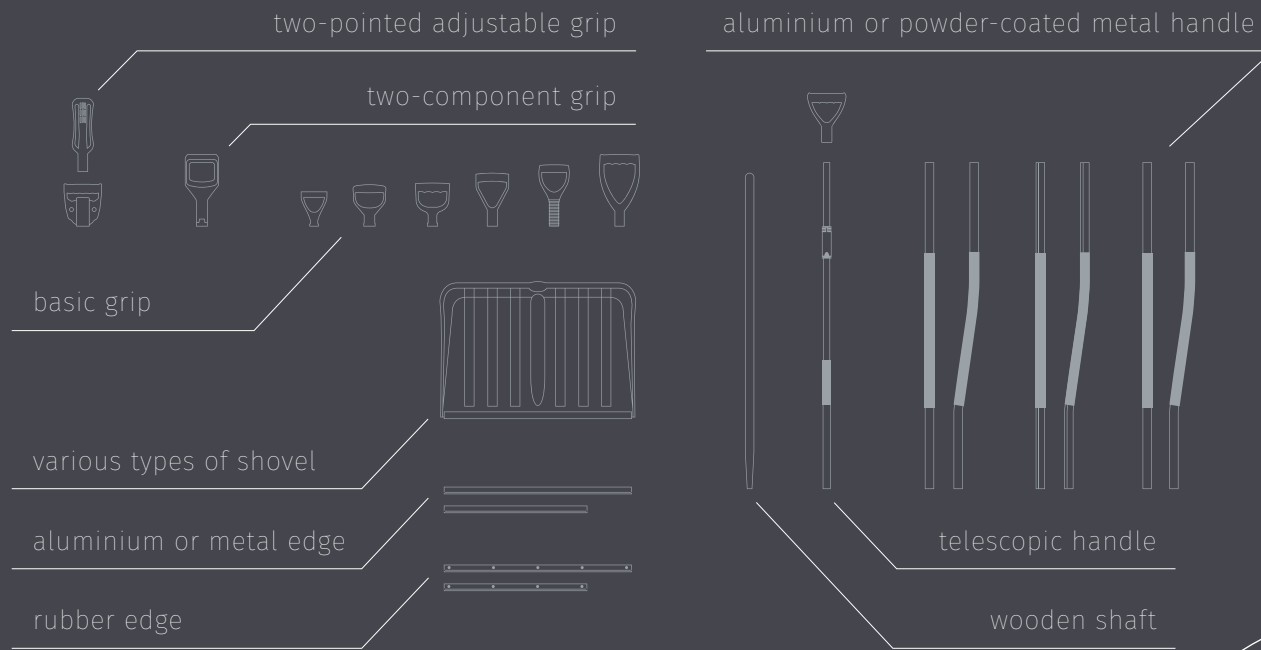

double
grip



Wychodząc naprzeciw potrzebom rynku, obok produkcji seryjnej, realizujemy również zamówienia uwzględniające indywidualne potrzeby i preferencje. Szeroka gama oferowanych przez nas komponentów zapewnia konfigurację kompletnego narzędzia od podstawowych rozwiązań ogólnego stosowania po zaawansowane technicznie, wielozadaniowe warianty, umożliwiające maksymalizację wydajności. Segment SPECIAL ORDER pozwala również na niemal nieograniczony dobór kolorów.

In response to growing market demand, along with standard production, we are welcome any orders with individual needs and preferences. The wide range of components and materials we offer make it for us possible to fulfill orders almost in any configuration with diverse solutions, technical requests, multi-tasking varieties, efficiency. SPECIAL ORDER range also allows us to create an endless colour selection.



PRACTIC ECO STANDARD snow shovel

	ILT375
	S411 5905197141428
	not assembled 480 1440
	assembled 160
	not assembled 10560 10560
	assembled 5280



NONAME 41 ECO STANDARD snow shovel

	ILT415
	S411 5905197141442
	not assembled 360 1440
	assembled 160
	not assembled 8640 8640
	assembled 5282



ASK FOR MOQ | special order



CLEAN SET ECO

multi-purpose set 2in1

	ILTCL1
	S411 5905197142036
	assembled 45
	assembled 1485



ICE SET ECO

multi-purpose set 2in1

	ILTZICE1
	S411 5905197142005
	assembled 70
	assembled 2310

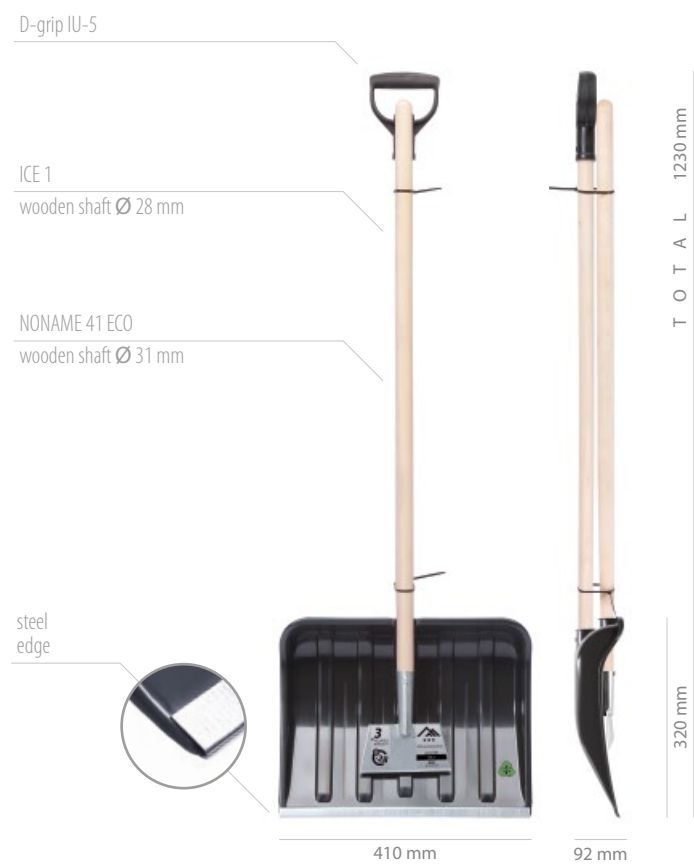

ALPIN ALUTUBE ERGO ECO

snow shovel

	ILT2TBE
	S411 5905197141480
	not assembled 300 350
	assembled 100
	not assembled 5400 5400
	assembled 3300



ALPINUS ALUTUBE ERGO ECO

snow shovel

	ILT3TBE
	S411 5905197141954
	not assembled 160 350
	assembled 70
	not assembled 3680 3680
	assembled 2240





ALPE 40 ECO TELESCOPIC snow shovel

	ILT40TSC
	S411 5905197141466
	not assembled 360 250
	not assembled 5760 5760



NANGA ECO snow shovel

	ILT30
	S411 5905197141411
	not assembled 420 1440
	not assembled 9240 9240
	assembled 184
	assembled 5888



NANGA ECO CAR car shovel

	ILTNG
	S411 5905197141978
	not assembled 420 3500
	not assembled 9240 9240
	assembled 130
	assembled 4290



NANGA ECO CAR ALU car shovel

	ILTNGA
	S411 5905197141985
	assembled 140
	assembled 9240





NANGA ECO TELESCOPIC snow shovel

	ILT30TSC
	S411 5905197141459
	assembled 120
	assembled 7920



PEAKSNOW



ALPIN 1 snow shovel

	IL1
	B333 5905197740515
	not assembled 360 1440
	assembled 160
	not assembled 8640 8640
	assembled 5280

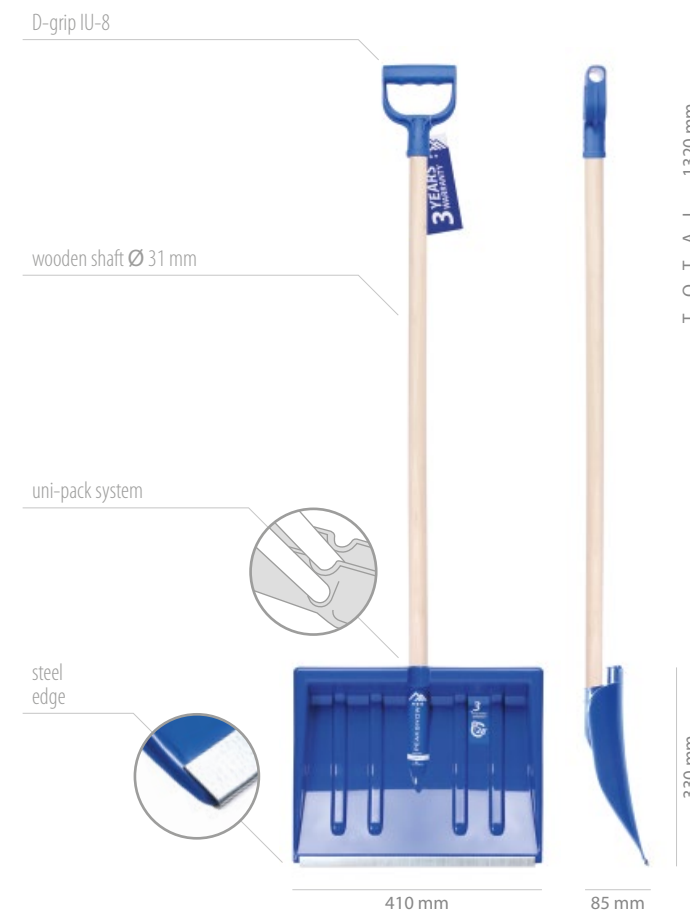

PEAKSNOW



ALPIN 2 snow shovel

	IL2
	B333 5905197740522
	not assembled 300 1440
	assembled 100
	not assembled 7500 7500
	assembled 3300

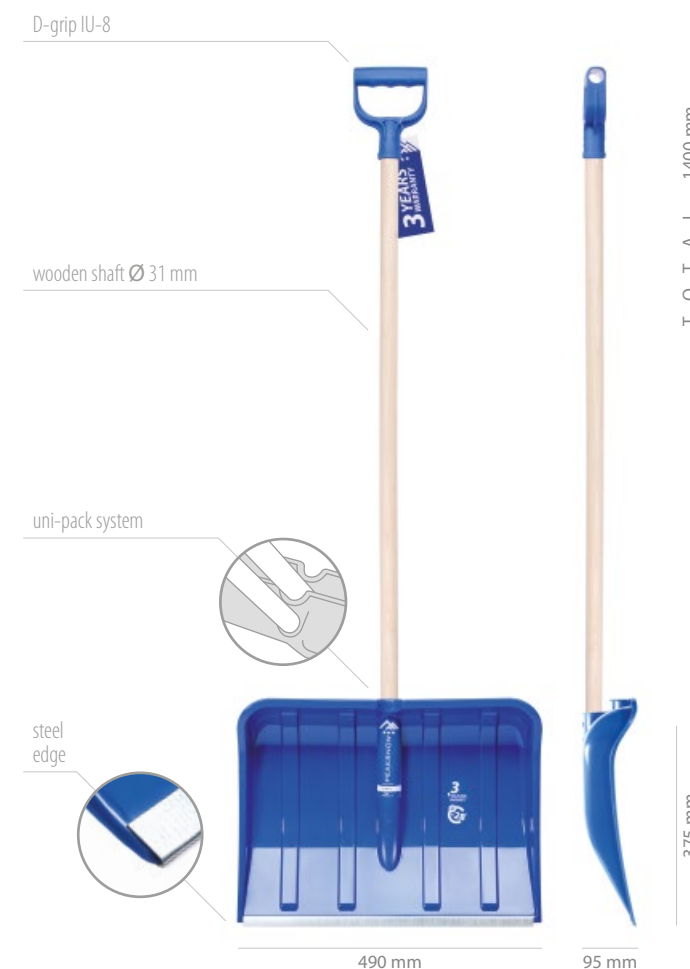

ALPIN 2 ALUTUBE ERGO snow shovel

IL2TBE		
B333	5905197142067	
not assembled	300	350
assembled	100	
not assembled	5400	5400
assembled	3300	



ALPINUS METAL snow shovel

RL3AMT		
R395	5905197131030	
not assembled	160	350
assembled	70	
not assembled	3680	3680
assembled	2240	



ALPINUS A snow shovel

IL3A		
B333	5905197141251	
not assembled	160	1440
assembled	70	
not assembled	4480	4480
assembled	2240	



ALPINUS ERGOMETAL snow shovel

IL3FE		
B333	5905197141282	
not assembled	160	350
assembled	70	
not assembled	3680	3680
assembled	2240	



PEAKSNOW



ALPINUS ERGOMETAL snow shovel

	RL3FE
	R395 5905197131047
	not assembled 160 350
	assembled 70
	not assembled 3680 3680
	assembled 2240



PEAKSNOW



ALPINUS TELESCOPIC snow shovel

	IL55TSC
	B333 5905197142081
	not assembled 160 250
	not assembled 3680 3680



PEAKSNOW



ERGONOMIC 1 A snow shovel

	ILE1A
	B333 5905197141664
	not assembled 360 1440
	assembled 160
	not assembled 8640 8640
	assembled 5280



PEAKSNOW



ERGONOMIC 2 A snow shovel

	ILE2A
	B333 5905197141688
	not assembled 200 1440
	assembled 100
	not assembled 4800 4800
	assembled 3300



ERGO ALUTUBE snow shovel

ILETB		
B333	5905197141305	
not assembled	200	350
assembled	100	
not assembled	4200	4200
assembled	3300	



NANGA snow shovel

IL30		
B333	5905197142043	
not assembled	420	1440
assembled	184	
not assembled	9240	9240
assembled	5888	



ALPE 40 TELESCOPIC snow shovel

IL40TSC		
B333	5905197142050	
not assembled	360	250
not assembled	5760	5760



LHOTSE [+ SACK] snow shovel

ILHOTW		
B333	5905197142234	
assembled	120	
assembled	7920	



SNOW RIDER 2 pusher

ILSR2	
S411	5905197140582
not assembled	30
assembled	30
not assembled	1980
assembled	990



ALUICE 40 P aluminium shovel

ILALP4	
ALU	5905197141602
not assembled	600
assembled	60
not assembled	12000
assembled	1980



SKANDYNAWIA STANDARD aluminium shovel

ILSK25	
ALU	5905197140391
not assembled	600
assembled	80
not assembled	12000
assembled	2640



RUBBER COVER for ICE 1 - ICE 2 - ICE 3





CLEAN SET

multi-purpose set 2in1

	ZCLE1
	B333 5905197199023
	assembled 45
	assembled 1485



FAMILY SET

multi-purpose set 2in1

	ZFAM
	B333 1788C 5905197199047
	assembled 70
	assembled 2310

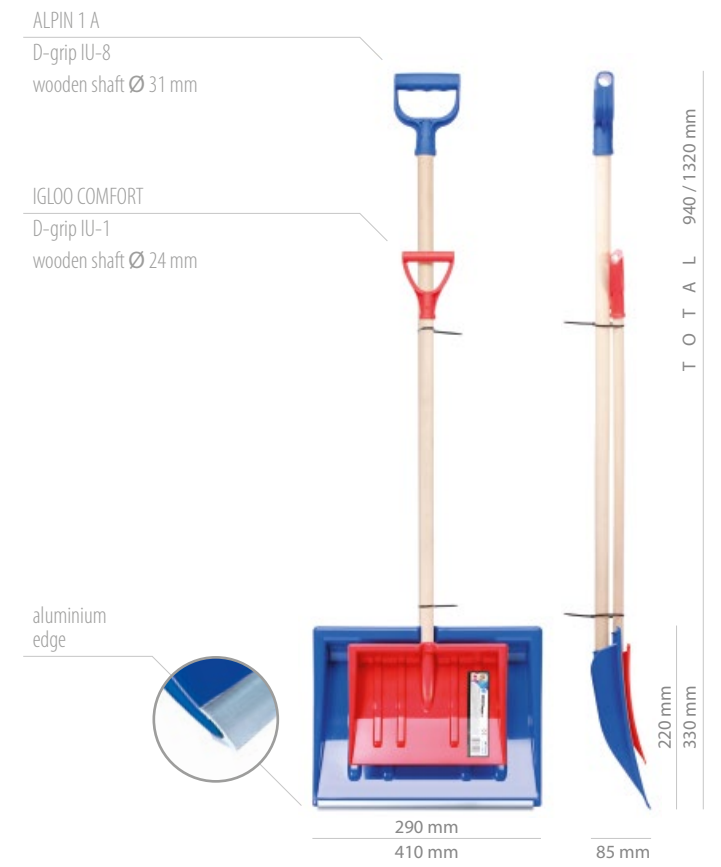

ICE SET

multi-purpose set 3in1

	ZICE1
	B333 STEEL 5905197199016
	assembled 70
	assembled 2310

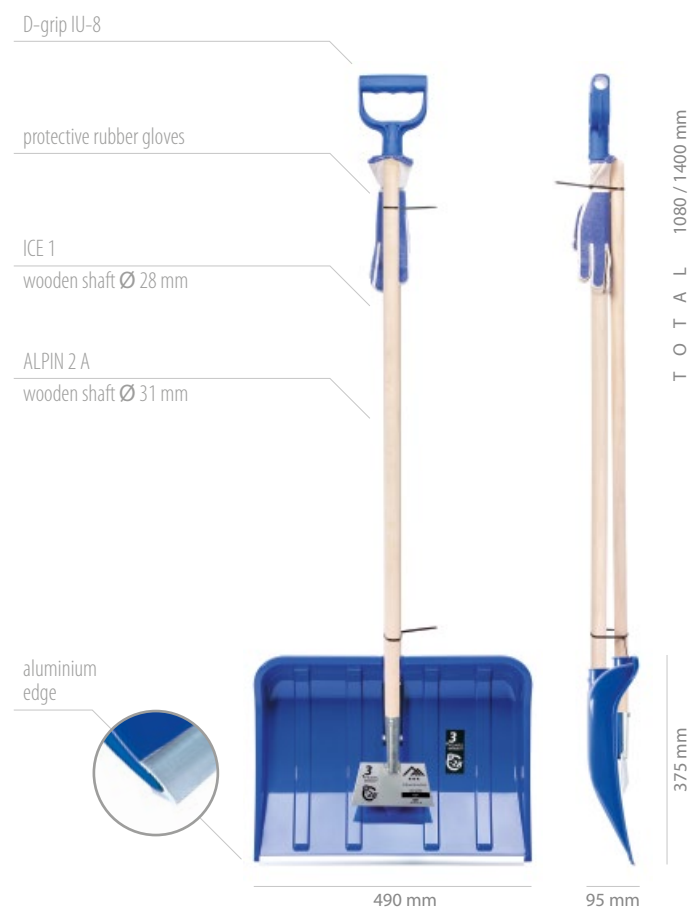

KID SET

multi-purpose set for kids 2in1

	ZKID
	3005U 1788C 5905197199030
	assembled 100
	assembled 3300

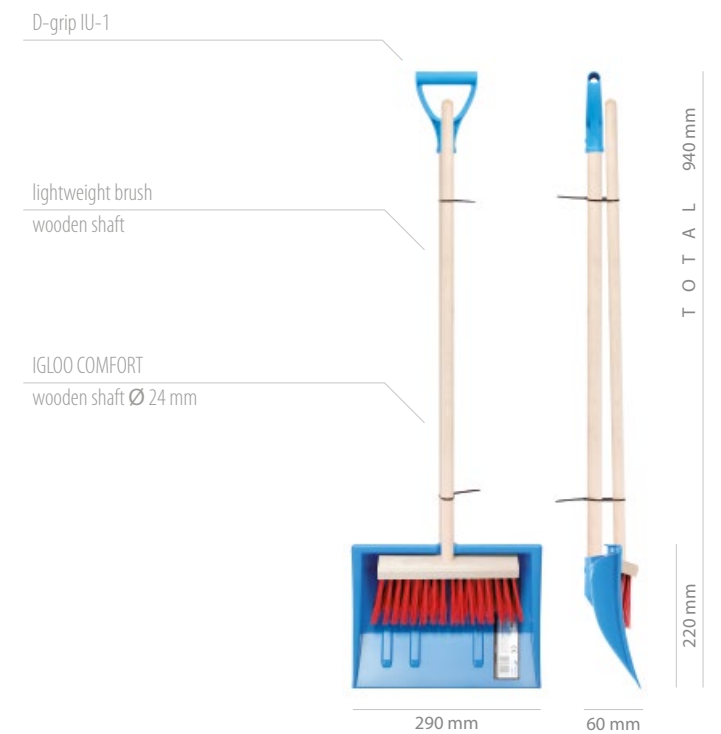

BOBO COMFORT

multi-purpose shovel

	IL02
	3005U 5905197140469
	1788C 5905197069661
	not assembled 960 2000
	assembled 150
	not assembled 21120 21120
	assembled 9900

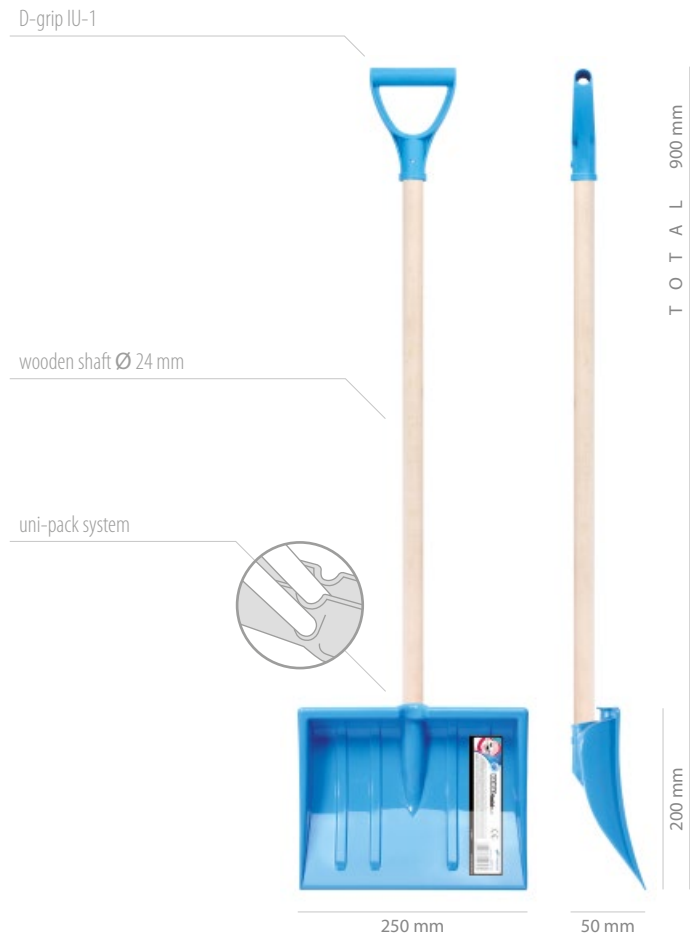

IGLOO

multi-purpose shovel

	ILM1
	3005U 5905197140476
	1788C 5905197095714
	205C 5905197097305
	not assembled 840 2000
	assembled 150
	not assembled 19320 19320
	assembled 9900



BOBO COMFORT ALU

multi-purpose shovel

	IL02A
	3005U 5905197140384
	1788C 5905197095646
	assembled 150
	assembled 9900

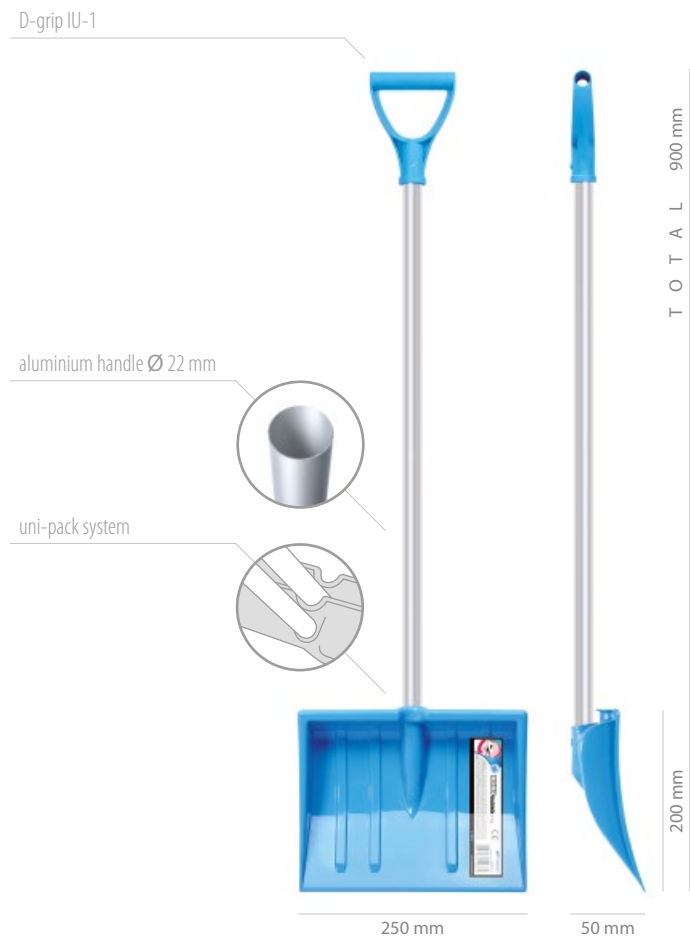

PEAKSNOW PREMIUM MAJSTER

professional shovel

	ILMSTA
	B333 5905197141572
	not assembled 200 300
	assembled 70
	not assembled 4200 4200
	assembled 2240





DIABLO ERGO

professional shovel

ILDBE		
R444	5905197142203	
not assembled	160	300
assembled	70	
not assembled	3360	3360
assembled	2240	



ERGOSPECIAL S

professional shovel

ILEXS		
B333	5905197141565	
not assembled	160	320
assembled	70	
not assembled	3520	3520
assembled	2240	



ERGOSPECIAL C

professional shovel

ILEX55C		
B333	5905197142296	
not assembled	160	160
assembled	70	
not assembled	2560	2560
assembled	2240	



ERGOSPECIAL C

























professional shovel

RLEX55		
R395	5905197131078	
not assembled	160	160
assembled	70	
not assembled	2560	2560
assembled	2240	



category index

BASIC SHOVELS WITH WOODEN SHAFT

				
ALPIN 1 p. 85	ALPIN 1 A p. 47	ALPIN 2 p. 85	ALPIN 2 A p. 47	ALPINUS A p. 86
				
ERGONOMIC 1 A p. 89	ERGONOMIC 2 A p. 89	STANDARD 1 p. 51	STANDARD 2 p. 52	NANGA p. 91
				
PRACTIC ECO STANDARD p. 79	PRACTIC ECO p. 71	NONAME 41 ECO STANDARD p. 79	NONAME 41 ECO p. 71	NONAME 47 ECO p. 72
				
ALPINUS ECO p. 72	NANGA ECO p. 83			
				
ALPE 40 TELESCOPIC p. 90	ALPE 50 TELESCOPIC p. 51	NANGA CAR TELESCOPIC p. 52	ALPINUS TELESCOPIC p. 88	
				
ALPE 40 ECO TELESCOPIC p. 82	ALPE 50 ECO TELESCOPIC p. 74	NANGA ECO CAR TELESCOPIC p. 74	NANGA ECO TELESCOPIC p. 84	

TELESCOPIC SYSTEM

SHOVELS WITH METAL HANDLE

				
SNOWER 40 ALUTUBE p. 23	SNOWER 40 PROFI p. 24	SNOWER 40 PROFI ERGO p. 25	SNOWER 50 ALUTUBE p. 27	SNOWER 50 PROFI p. 28
				
SNOWER 50 PROFI ERGO p. 29	SNOWER 55 ALUTUBE p. 31	SNOWER 55 PROFI p. 32	SNOWER 55 PROFI ERGO p. 33	SNOWER 55D ALUTUBE p. 35
				
SNOWER 55D PROFI p. 36	SNOWER 55D PROFI ERGO p. 37	RAKE LOADER p. 38	DIABLO p. 39	DIABLO ERGO p. 98
				
MAJSTER p. 97	ERGOSPECIAL p. 39	ERGOSPECIAL S p. 98	ERGOSPECIAL C p. 99	ERGOSPECIAL C p. 99
				
ALPIN 2 METAL p. 48	ALPIN 2 ALUTUBE p. 48	ALPIN 2 ALUTUBE ERGO p. 86	ALPINUS ALUTUBE ERGO p. 50	ALPINUS ALUTUBE p. 49
				
ALPINUS METAL p. 49	ALPINUS ERGOMETAL p. 87	ALPINUS METAL p. 87	ALPINUS ERGOMETAL p. 88	ERGOMETAL p. 50
				
ERGO ALUTUBE p. 90	ALPIN ALUTUBE ECO p. 73	ALPIN ALUTUBE ERGO ECO p. 81	ALPINUS ALUTUBE ECO p. 73	ALPINUS ALUTUBE ERGO ECO p. 81

category index

PUSHER SERIES



ALUMINIUM SHOVELS

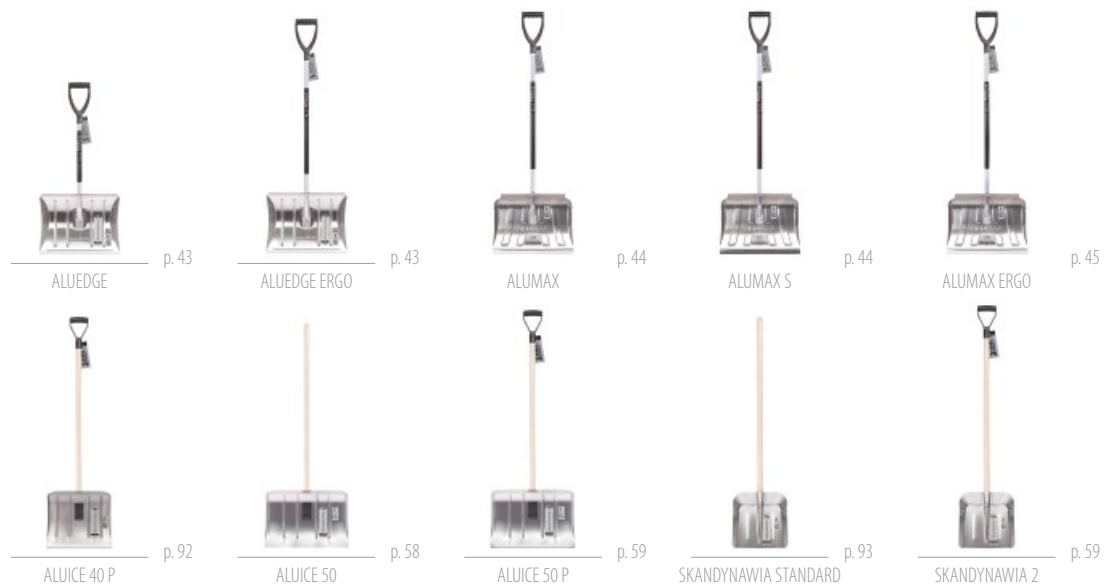

ICE & ACCESSORIES

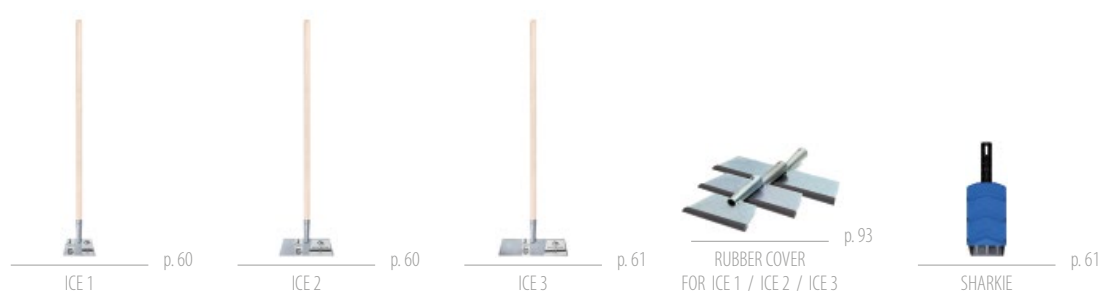

CAR SHOVELS & ACCESSORIES



SET

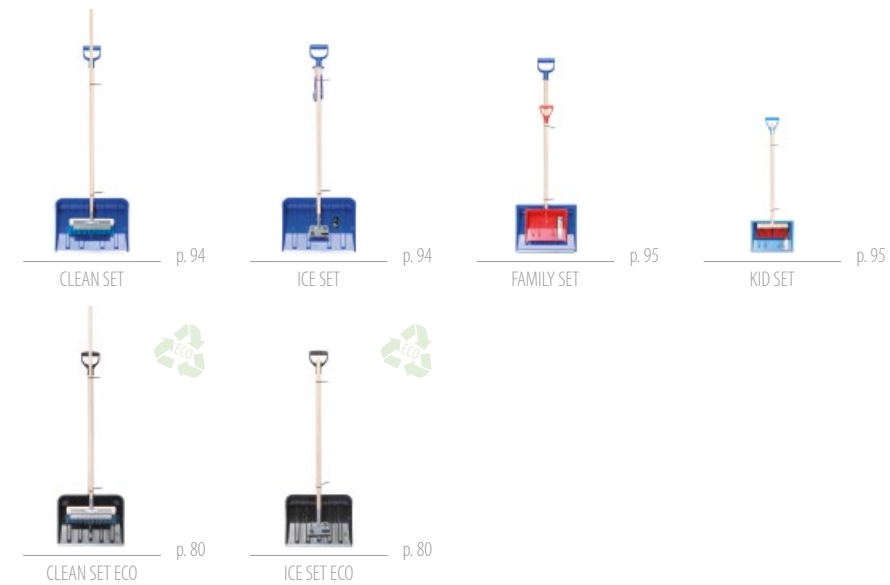

FOR KIDS

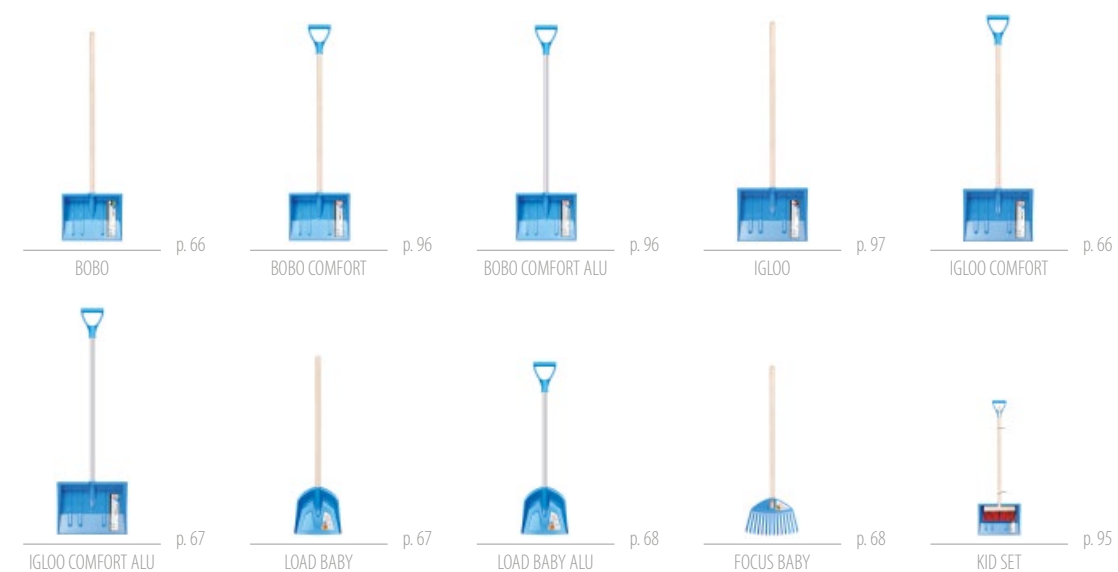

logistic & packing method





exhibition



logistics



production

designations

in the tables pictographs]



symbol
symbol



kod EAN
EAN code



ilość sztuk na europalecie
number of pieces on an Europalette



ilość sztuk - TIR
truck quantity



szufle - nie zmontowane
shovels - not assembled



szufle - nie zmontowane
handles - not assembled



łopaty zmontowane
assembled shovels

certificates





Headquarter, production & warehouse
Prosperplast 1 Sp. z o. o.
43-378 Rybarzowice
ul. Wilkowska 968
Polska

tel. +48 33 817 70 03
fax +48 33 817 60 81

biuro@prosperplast.pl
office@prosperplast.pl
www.prosperplast.pl

Production & warehouse
Prosperplast 1 Sp. z o. o.
43-374 Buczkowice
ul. Wczasowa 733A
Polska

tel. +48 33 817 70 03
fax +48 33 817 60 81
www.prosperplast.pl

Production & warehouse
Prosperplast 1 Sp. z o. o.
34-300 Żywiec
ul. Leśnianka 81
Polska

tel./ fax +48 33 475 05 86
www.prosperplast.pl

Warehouse
Prosperplast 1 Sp. z o. o.
43-365 Wilkowice
ul. E. Kwiatkowskiego 23
Polska

tel. +48 33 817 70 03
www.prosperplast.pl



Office
Prosperplast Deutschland GmbH
Hopfenstraße 22a
85283 Wolnzach
Deutschland

tel. +49 8442 9628499
tel. +49 8442 9588 30
fax +49 8442 9680853

kontakt@prosperplast.de
www.prosperplast.de

Warehouse
Prosperplast Deutschland GmbH
Weststrasse 6
02708 Löbau
Deutschland

tel. +49 03585 4688278
fax +49 03585 4688274

kontakt@prosperplast.de
www.prosperplast.de



Office
Prosperplast s.r.o.
V Zátíši 810/1
709 00 Ostrava - Mariánské Hory
Czech Republic

Warehouse
Prosperplast s.r.o.
Nošovice 330
739 51 Nošovice
Czech Republic

tel. +420 553 034 443
mob +420 730 894 721

info@prosperplast.cz
www.prosperplast.cz



Office
Prosperplast Kft.
1136-H Budapest,
Tátra u. 5/a, alagsor 2.
Magyarország

tel. +36 30 4095 120
mob +36 30 4095 710

office@prosperplast.hu
www.prosperplast.hu

Pragniemy przewidywać Twoje potrzeby i być zawsze o krok do przodu, aby Cię usatysfakcjonować. Dlatego przygotowaliśmy katalog na 2022 rok pełen produktów, które z łatwością wkroczą w Twoje codzienne życie.

We want to foresee your needs and always be one step ahead to make you satisfied.

That is why we prepared this catalogue for 2022 filled with products that will easily step into your everyday life.

Wszystkie prawa zastrzeżone przez Prosperplast 1 Spółka z o.o., a zawartość nie może być powielana, pobierana, rozpowszechniana, publikowana lub przekazywana w jakiegokolwiek formie i w jakikolwiek sposób, bez uprzedniej pisemnej zgody Prosperplast 1 Spółka z o.o. Niniejszy katalog nie stanowi oferty w rozumieniu obowiązujących przepisów. Za błędy w druku nie odpowiadamy.

All rights are reserved by Prosperplast 1 Spółka z o. o. and content may not be reproduced, downloaded, disseminated, published or transferred in any form or by any means, except with the prior written permission of Prosperplast 1 Spółka z o.o. This catalogue does not constitute an offer within the meaning of applicable rules. We are not responsible for printing errors.