



# FERNE

have a seat.

**FERNE**

have a seat.

# A new brand based on over 30 years of experience.

We believe that everyone deserves to be surrounded by beauty and comfort. That's why we have created FERNE: a fresh brand of outdoor and indoor furniture, manufactured in Poland, in the heart of Europe. FERNE responds to the growing demand for furniture that is both comfortable and aesthetic. The brand is based on more than 30 years of Prosperplast's experience, offering high-quality products that are both comfortable and beautiful. Our furniture, produced in Central Europe, fits gardens, homes, and commercial spaces such as offices, cafes, and hotels.

FERNE is our latest brand. Prosperplast, a family company, specializes in innovative plastic processing technologies. We are a global organization with local production plants in small towns in Southern Poland, selling products in more than 90 countries.

Over the years, we have focused on injection molding, blow molding, and rotational molding—each offering different plastic forming methods, providing new uses and applications.

Our three decades of business operations have given us extensive experience and unique know-how. Our team of experts and modern machinery guarantee top quality. We rely on extensive infrastructure, with our own transport fleet and over 200 thousand square meters of warehouse and production space in Poland, Germany, Czechia, and Hungary. This allows us to successfully carry out projects and deliver innovative solutions that meet our customers' needs.

Since 1993, we have designed and produced numerous creative solutions for homes and gardens, including flower pots, rainwater tanks, garden tools, toolboxes, and storage systems. Now it's time for furniture.

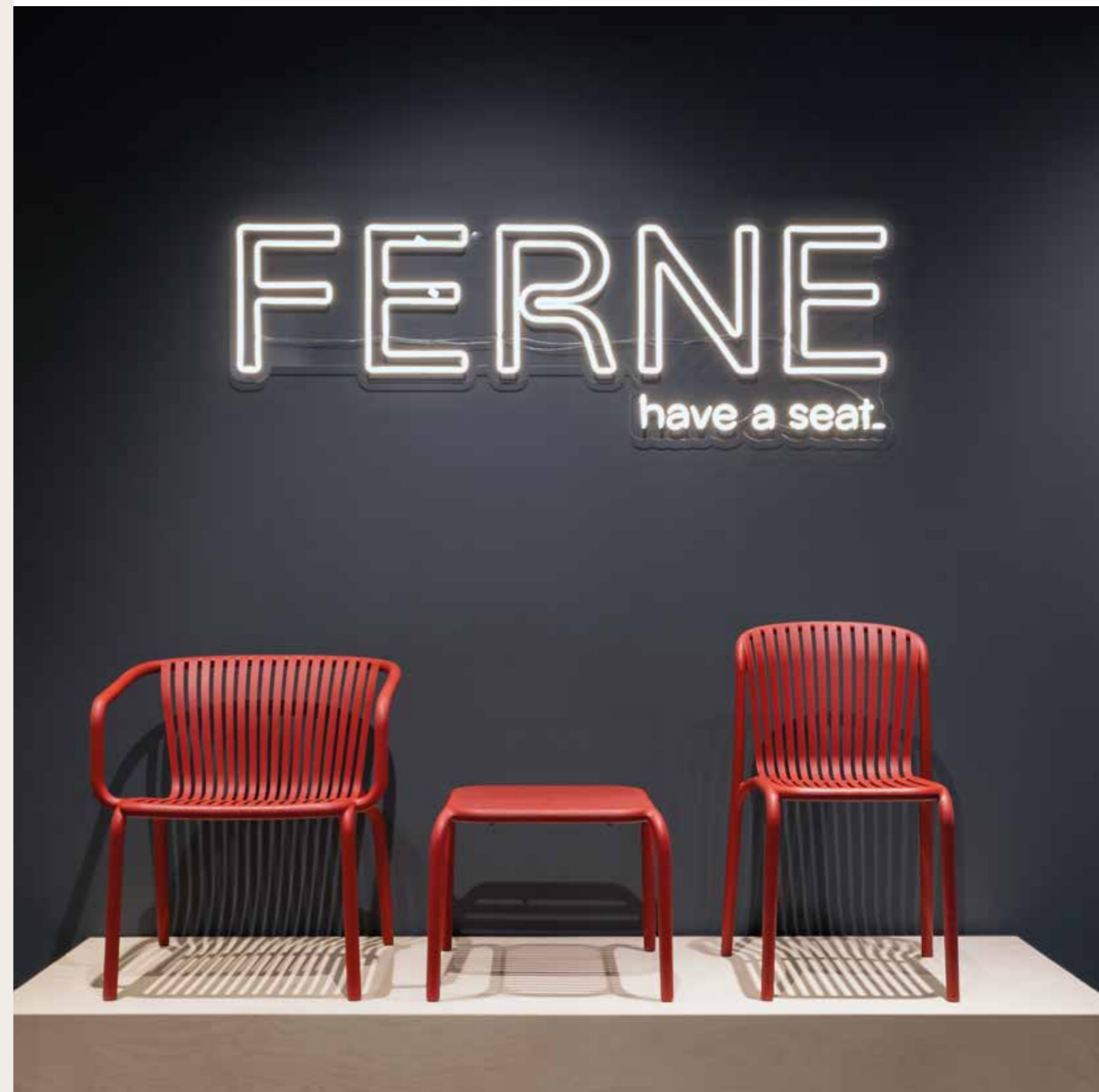

We warmly invite you to visit the FERNE showroom at our headquarters in Rybarzowice, southern Poland.  
In the photo: the BRENE collection.  
Learn more on page 10.





We design furniture with the utmost focus on user comfort.  
In the photos: The design process of the BRENE collection.  
Learn more on page 10.

## Comfort-focused design.

User comfort is the priority of our brand. In designing FERNE furniture, we follow the latest global design trends, which contribute to the timelessness of our collections. With in-depth knowledge of materials and their unique properties - such as elasticity, lightness, and resistance to damage - we create furniture that is not only comfortable for everyday use but also easy to transport and store.

Every FERNE furniture model is designed with the user's maximum comfort in mind, achieved without the need for additional upholstered elements. The use of plastics, which are 100% recyclable, allows us to offer products as an eco-friendly alternative to furniture made from valuable primary resources like wood or rattan.

## Quality widely available.

We are deeply convinced that furniture of the best quality should be available to anyone who values beauty and comfort. At FERNE, our goal is to offer first-rate products at affordable prices. To achieve that, we cooperate with renowned design studios from Poland and other countries.

As Prosperplast, based on our 30 years of experience, we have used the existing distribution channels, advanced logistics, and efficient manufacturing processes to turn our vision into reality. What matters to us as well is building long-lasting and committed relationships with our business partners. As we are in constant dialogue with our customers to make sure we understand their needs, we deliver timely and reliable solutions that meet their expectations.

## The circular nature of plastics.

Circularity is one of the key standards at Prosperplast, alongside quality and safety. Our priority objective is to effectively manage resources in line with our philosophy of sustainable development.

Currently, recycled materials from external sources constitute around 40% of all the materials used in our manufacturing plants. We are constantly increasing the use of the recycle thanks to the rapid growth of the plastic recycling sector in Europe.

The furniture by FERNE is characterised by its durability, lightness, and 100% recyclability.

As a large manufacturer, we build internal closed loops of resources, water, and energy. The closed-loop production process reduces the use of industrial water and heat. What's more, we have our own photovoltaic power plant to reduce our carbon footprint even further. In 2023, thanks to our resource management strategies, only 0.5% of our plastic waste had to be recycled externally.





## Rooted in local furniture heritage.

Hardworking, professional, and innovative — the people who live in our region have always been like this. That's why FERNE draws on the rich local furniture tradition that dates back to the 19th century. It was then that bentwood furniture manufacturing developed in the city of Bielsko-Biala and in the region, following the methods by Michael Thonet. As an outstanding entrepreneur with a pioneer spirit, he launched the production of beautiful and functional beechwood furniture, accessible to the general public.

In the 1920s and 1930s, our region was also a leading manufacturing centre of nickel-plated bent tubes furniture. It was from here that Bauhaus icons, created by excellent designers such as Bruno Weil and Marcel Breuer, were sent out into the entire world.

Building on the legacy of Michael Thonet, we have written a new chapter of the local history of furniture manufacturing. At Prosperplast, we produce affordable, durable, and lightweight furniture with a timeless design aesthetic, at the same time taking up new challenges and using innovative plastics processing technologies. Our products are environment-friendly and fully recyclable.

## Redefining excellence.

The Brene Collection by FERNE has been honored with the prestigious German Design Award 2025, recognizing its innovative design, exceptional functionality, and timeless aesthetic. This esteemed accolade, presented by the German Design Council, celebrates outstanding contributions to the field of design and highlights projects that push boundaries while remaining relevant in a global context.

As one of the most respected awards in the design industry, the German Design Award stands as a benchmark for excellence, rewarding products and concepts that redefine creativity and set new standards for innovation. This recognition further underscores FERNE's commitment to merging the legacy of traditional craftsmanship with modern, sustainable solutions that resonate with contemporary lifestyles.



## Brene collection



**Chair**

p. 16 / p. 54



**Chair with armrests**

p. 16 / p. 54



**Armchair**

p. 16 / p. 54



**Side table**

p. 18 / p. 55



**Coffee table**

p. 18 / p. 55



**Dining table**

p. 18 / p. 55



**must  
have**

## Milane collection



**Chair**

p. 40 / p. 60



**Chair with armrests**

p. 40 / p. 60



**Armchair**

p. 40 / p. 60



**Sofa**

p. 43 / p. 61



**Side table & stool**

p. 43 / p. 61



**Coffee table**

p. 43 / p. 61

## Rimo collection



**Chair**

p. 27 / p. 56



**Chair with armrests**

p. 27 / p. 56



**Armchair**

p. 27 / p. 56



**Low bar chair**

p. 28 / p. 57



**High bar chair**

p. 28 / p. 57



**Square coffee table**

p. 30 / p. 58



**Square dining table**

p. 30 / p. 58



**Coffee table**

p. 33 / p. 58



**Dining table**

p. 33 / p. 59



**Side table**

p. 34 / p. 59



**High side table**

p. 34 / p. 59

## Lottie collection



**Side table & stool**

p. 49 / p. 62



**Coffee table**

p. 49 / p. 62



**Dining table**

p. 49 / p. 62

## Premo collection



**Chair with armrests**

p. 53 / p. 63  
Premo five



**Chair with armrests**

p. 53 / p. 63  
Premo six



**Chair with armrests**

p. 53 / p. 63  
Premo seven

## Logistics data

p. 54 / p. 63



FERNE



# Brene

The BRENE collection draws inspiration from timeless and iconic bentwood furniture.  
In the photos: Chairs and armchairs from the BRENE collection,  
elegantly arranged alongside other furniture pieces.





# Timeless and light beauty.

The BRENE collection redefines design. It has been inspired by the timeless and iconic bentwood furniture which was manufactured in the region of Bielsko-Biała in the early 20th century.

The projects are marked by visual lightness and elegance, which match both modern and classic spaces. The cohesive colour palette has been carefully designed to create one-of-a-kind arrangements by freely combining pieces in different colours. All of the above makes the BRENE collection perfect for versatile uses.

When designing the furniture, we placed emphasis on human-oriented ergonomics, with the users' needs in mind. The seats and backrests are made of breathable slats and they adapt naturally to the body shape for ultimate comfort. All the items in the collection are lightweight and easy to carry. Their construction prevents water pooling, so they are hard-wearing and easy to clean as well. With its top-notch quality, durability, and timeless design, the BRENE collection is made to last. What's more, particular pieces can be stacked, which makes their storage extremely convenient. All these features mean that every element of the BRENE collection is a synonym for elegance, corresponding with the needs of the most demanding design lovers. The collection consists of a coffee table, an side table, a dining table, a chair, a chair with armrests, and an armchair.



The lightweight construction of the BRENE collection ensures that all items are easy to move and store.

In the photo: BRENE armchairs showcased in a dynamic logistics environment, highlighting their versatility and adaptability.

In the photo on the right: BRENE armchairs elegantly paired with a matching side table, creating a stylish and functional ensemble.



have a seat.



# FERNE



The seats and backrests of the BRENE collection are crafted from breathable slats that naturally adapt to the body's shape, ensuring ultimate comfort.  
In the photo: A thoughtfully curated arrangement of chairs, armchairs, chairs with armrests, and side tables graces the terrace of the Pod Dębocem restaurant, combining comfort with style in a charming outdoor setting.





Chair

FBRK558

520 x 530 x 825



Chair with armrests

FBRK658

575 x 530 x 825



Armchair

FBRK767

670 x 625 x 740



# Brene

The seating options that form the BRENE collection are exceptionally practical and comfortable.

The triangular slats ensure airiness and comfort of sitting. The lightweight construction of the chairs makes them easy to move and store. All the BRENE chairs are moisture-resistant and can be stacked.

They are a perfect choice for both outdoors and indoors — they will work well in any conditions that require durability and resistance.



have a seat.





Side table

FBR554

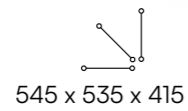

Coffee table

FBR5884

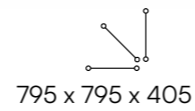

Dining table

FBR5888

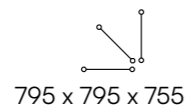

# Brene

BRENE tables, coffee tables, and side tables allow for comprehensive space arrangement. Thanks to the use of slat designs, the tables are lightweight, easy to clean, yet solid and durable.

The stackable feature makes the collection functional wherever storage is important. The legs for the table and coffee table are packaged separately and are very easy for the user to assemble, which improves logistical aspects.





# FERNE



# Rimo

The RIMO collection seamlessly blends classic elegance with modern materials and functionality. Featured in the photos: high bar chairs at a stylish counter, alongside chairs and armchairs perfectly complementing a kitchen space.





# Light classic collection.

The RIMO collection combines the elegance of classic bentwood furniture with modern design and functionality. Here, tradition meets innovation, and the classic form is paired with modern moulding methods and materials. The gentle rounded shapes that allude to Thonet's designs are coupled with stylish colours to give the furniture a delicate and fashionable look.

The smooth lines and "bent" elements create a harmonious combination of classic design and modern solutions. Made with precision and attention to detail, the collection is of prime quality. The RIMO furniture is functional and comfortable while retaining timeless aesthetics. It's a sustainable and affordable alternative to traditional wooden chairs.

The collection comprises a chair, a chair with armrests, an armchair, two bar chairs of different heights, a round side table, a round high side table, coffee tables, and dining tables.



In the photos: an armchair and a low bar chair from the RIMO collection and a tall side table.



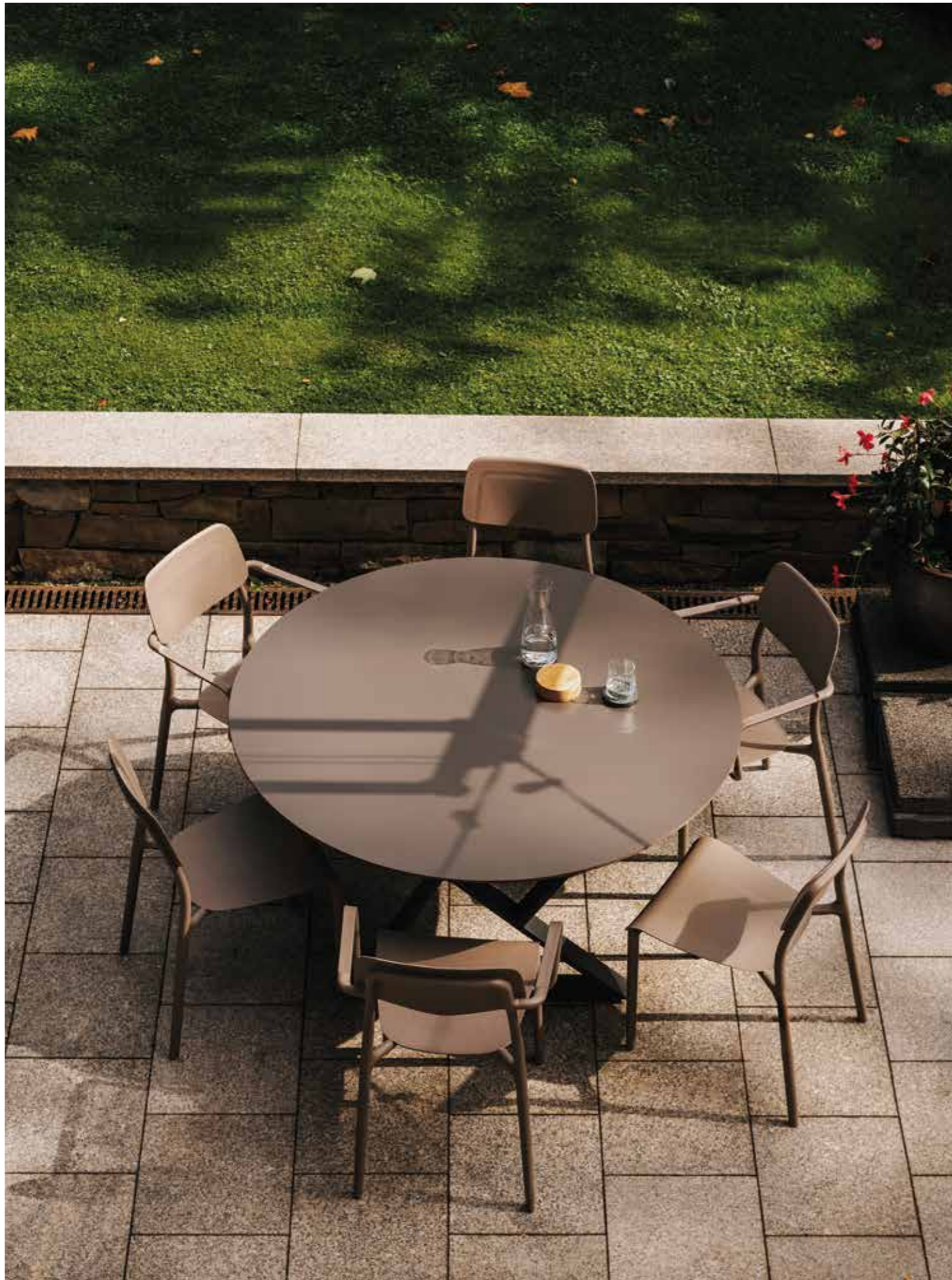

## FERNE



RIMO furniture is functional and comfortable, while maintaining a timeless aesthetic.  
In the photos: Chairs with armrests from the RIMO collection elegantly paired  
with a restaurant table, complemented by high bar chairs at the bar counter.





Chair

FRIK568

475 x 555 x 840



Chair with armrests

FRIK658

570 x 555 x 840



Armchair

FRIK667

620 x 625 x 748

# Rimo

The chairs from the RIMO collection are an example of a harmonious match between classic design and modern functionality.

The designers focused equally on how the chairs look and how comfortable they should be. This resulted in an original system of testing the ergonomics of the chairs and optimising their weight.

What's more, as the chairs are stackable, they can be easily rearranged and stored. Comfort and stability are ensured by the rubber chair feet.

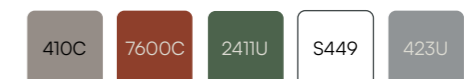

structure effect





Low bar chair

FRIK5510

520 x 545 x 985



High bar chair

FRIK5511

520 x 545 x 1075

# Rimo

The bar chairs by RIMO manifest the elegance of classic design and high production quality.

They come in two heights. Their gentle shapes and delicate lines as well as light construction and refined details make them an ideal element of outdoor and indoor decors.

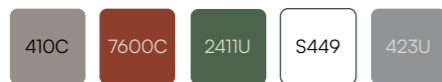

structure effect







Square coffee table

FRIS884

775 x 775 x 405



Square dining table

FRIS887

775 x 775 x 745

# Rimo

The square tables by RIMO are perfect for homes and gardens. They are robust, elegant, and made with care. A table like this is not only a practical piece of furniture but also an eye-pleasing touch to any kind of space. Thanks to their universal design and weather resistance, the tables will find their place on a terrace or in a garden. They bring functional elegance to every spot.

The legs for the dining table and the coffee table are packed separately and they are very easy to assemble. Transporting furniture in parts is a great way to reduce carbon foot print and improve the overall logistics.



structure effect





Dining table

FRIS867

775 x 575 x 745



Coffee table

FRIS864

775 x 575 x 405

# Rimo

The rectangular tables by RIMO are perfect for homes and gardens. They are robust, elegant, and made with care. A table like this is not only a practical piece of furniture but also an eye-pleasing touch to any kind of space. Thanks to their universal design and weather resistance, the tables will find their place on a terrace or in a garden. They bring functional elegance to every spot.

The legs for the dining table and the coffee table are packed separately and they are very easy to assemble. Transporting furniture in parts is a great way to reduce carbon footprint and improve the overall logistics.



structure effect





Side table

FRIS64

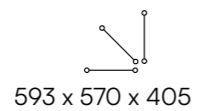

593 x 570 x 405

# Rimo

The round tables by RIMO are a perfect match for gardens and home interiors, cafes, and leisure spaces. With their elegant design, solid construction, and universal nature, the tables are a great addition to any arrangement.

The legs are packed separately and they are very easy to assemble. Transporting furniture in parts is a great way to reduce carbon foot print and improve the overall logistics.

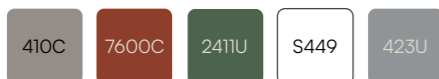

structure effect



High side table

FRIS67

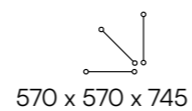

570 x 570 x 745





FERNE



# Milane

The MILANE collection is characterized by a minimalist style, exceptional seating comfort, and streamlined logistics.  
In the photos: a set of chairs, armchairs, a chair with armrests, and a side table in the garden.





## Available comfort.

MILANE is an impressive collection of comfortable garden furniture. Its characteristics include the minimalist style, exceptional sitting comfort, and simple logistics. As monolithic forms are very popular among users, we have decided to create an entire collection in this spirit. By optimising the production process, we've made sure the collection is affordable for the wide public.

With their distinctive bends and soft shapes, all the pieces look strong and attractive, ensuring stability and durability. The single-point injection technology used in the MILANE collection created the smooth shapes of the furniture, emphasised by the satin finishing. The collection offers an array of subtle, timeless colours. MILANE comprises a chair, a chair with armrests, an armchair, and an side table that can also serve as a stool.



In the photos: a garden set featuring armchairs with a side table, as well as a single armchair from the MILANE collection.



Chair

FMIK667

580 x 600 x 735



Chair with armrests

FMIK768

680 x 600 x 805



Armchair

FMIK777

745 x 730 x 735

# Milane

The chairs and armchairs by MILANE are lightweight and easy to move, store, and clean.

This makes them functional, practical, and widely available. What's more, the chairs can be easily stacked on top of one another.

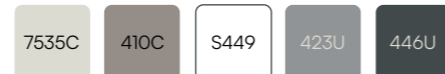





Coffee table

FMIS863

790 x 590 x 340



Sofa

FMIK1277

1200 x 735 x 732



Side table & stool

FMIS554

485 x 485 x 420

# Milane

The Milane collection is an ideal choice for garden design. A two-seater bench, an armchair, and a low side table will enrich your outdoor space. The side table is distinguished by its elegance and versatility, serving as a table, stool, or footrest.



FERNE



# Lottie

LOTTIE is a family of essential, stylish, and functional garden tables that perfectly complement the chairs from the Premo collection.  
In the photo: Chairs from the PREMO collection paired with the LOTTIE dining table on a garden terrace.





## Perfect for interiors and gardens.

LOTTIE is a family of stylish and functional tables that will be a great fit for every type of garden or leisure space. The tables are very easy to clean, use, and store. The family comprises a dining table, a coffee table, and a side table, which can also be used as a stool.

The LOTTIE products are available in classic, neutral colours, making them easy to pair with other FERNE items. Designed to enhance both interiors and gardens, the LOTTIE tables combine versatility and elegance, adding charm to any setting.



In the photos: a side table from the LOTTIE collection paired with a home furniture set, as well as a visualization of a coffee table and a side table & stool.



have a seat.



Side table & stool

FLOS445

396 x 396 x 465



Dining table

FLOS888

775 x 775 x 765



Coffee table

FLOS866

770 x 590 x 565

# Lottie

The tables are very easy to clean, use, and store. The collection comprises a high table, a coffee table, and a side table, which can be used as a stool.

7535C

4193C

443U

446U

FERNE



FERNE



# Premo

The chairs from the PREMO collection are available in three variants and perfectly complement the LOTTIE table collection, creating a cohesive and elegant arrangement for any space, both indoors and outdoors.  
In the photos: Chairs from the PREMO collection, elegantly paired with the LOTTIE dining table, creating a charming arrangement in the garden.





**Premo five**  
Chair with armrests

FPRK568

540 x 590 x 810



**Premo six**  
Chair with armrests

FPRK658

590 x 560 x 815



**Premo seven**  
Chair with armrests

FPRK758

630 x 560 x 825

# Premo

PREMO is a modern interpretation of a classic garden chair. The product comes in three variants. It's perfect for places where quick rearrangements happen on a daily basis: the chairs can be easily moved in, out, and around, and they are convenient to store.

The PREMO chair is an attractive and functional solution for every balcony, garden, and stylish cafe. It has been carefully designed also in terms of colour and form.







**Brene**  
Chair

symbol:	dimensions (mm): length /width /height	maximum weight:	packaging (pcs):	pallet height:	stackable:
FBRK558	520 x 530 x 825	110	24	~ 1700	✓



**Brene**  
Side table

symbol:	dimensions (mm): length /width /height	maximum weight:	packaging (pcs):	pallet height:	stackable:
FBR554	545 x 535 x 415	50	24	~ 1040	✓



**Brene**  
Chair with armrests

symbol:	dimensions (mm): length /width /height	maximum weight:	packaging (pcs):	pallet height:	stackable:
FBRK658	575 x 530 x 825	110	24	~ 1700	✓

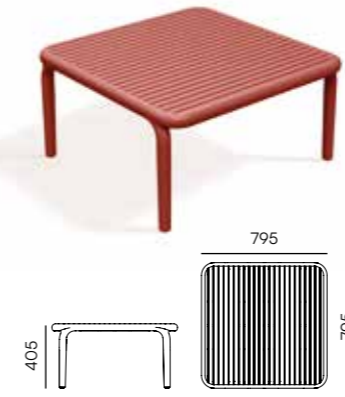

**Brene**  
Coffee table

symbol:	dimensions (mm): length /width /height	maximum weight:	packaging (pcs):	pallet height:	stackable:
FBR5884	795 x 795 x 405	100	12	~ 1805	✓



**Brene**  
Armchair

symbol:	dimensions (mm): length /width /height	maximum weight:	packaging (pcs):	pallet height:	stackable:
FBRK767	670 x 625 x 740	110	14	~ 1670	✓



**Brene**  
Dining table

symbol:	dimensions (mm): length /width /height	maximum weight:	packaging (pcs):	pallet height:	stackable:
FBR5888	795 x 795 x 755	100	12	~ 1805	✓

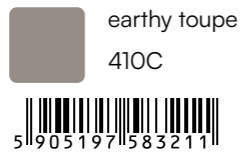
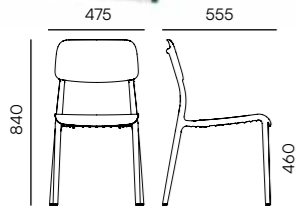

structure effect

### Rimo

Chair

FRIK568

symbol:	dimensions (mm): length /width /height	maximum weight:	packaging (pcs):	pallet height:	stackable:
	475 x 555 x 840	110	20	~ 1700	✓

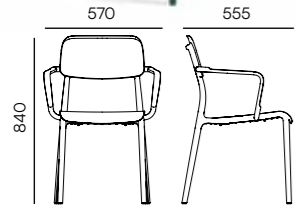

structure effect

### Rimo

Chair with armrests

FRIK658

symbol:	dimensions (mm): length /width /height	maximum weight:	packaging (pcs):	pallet height:	stackable:
	570 x 555 x 840	110	16	~ 1740	✓

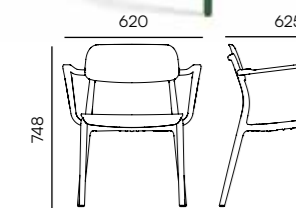

structure effect

### Rimo

Armchair

FRIK667

symbol:	dimensions (mm): length /width /height	maximum weight:	packaging (pcs):	pallet height:	stackable:
	620 x 625 x 748	110	8	~ 1050	✓

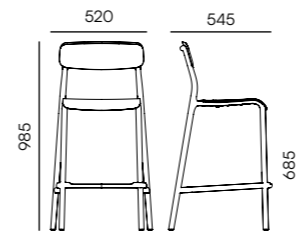

structure effect

### Rimo

Low bar chair

FRIK5510

symbol:	dimensions (mm): length /width /height	maximum weight:	packaging (pcs):	pallet height:	stackable:
	520 x 545 x 985	110	10	~ 1200	✓

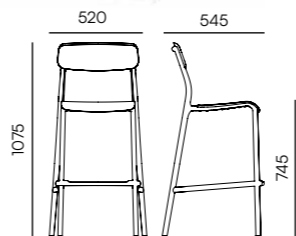

structure effect

### Rimo

High bar chair

FRIK5511

symbol:	dimensions (mm): length /width /height	maximum weight:	packaging (pcs):	pallet height:	stackable:
	520 x 545 x 1075	110	10	~ 1360	✓







earthy toupe  
410C



burnt brick  
7600C



pine green  
2411U

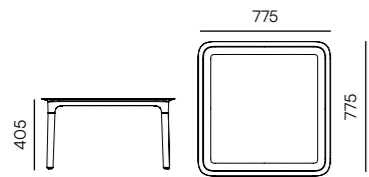

white  
S449



agate gray  
423U



structure effect

### Rimo

Square coffee table

symbol:

dimensions (mm): length /width /height

maximum weight:

packaging (pcs):

pallet height:

stackable:

FRIS884

775 x 775 x 405

100

26

~ 1910

✓



earthy toupe  
410C



burnt brick  
7600C



pine green  
2411U

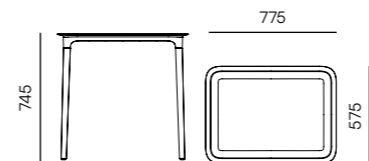

white  
S449



agate gray  
423U



structure effect

### Rimo

Dining table

symbol:

dimensions (mm): length /width /height

maximum weight:

packaging (pcs):

pallet height:

stackable:

FRIS867

775 x 575 x 745

100

36

~ 1915

✓



earthy toupe  
410C



burnt brick  
7600C



pine green  
2411U

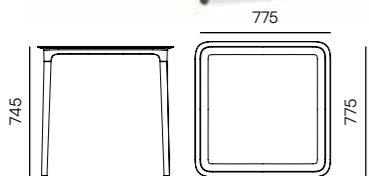

white  
S449



agate gray  
423U



structure effect

### Rimo

Square dining table

symbol:

dimensions (mm): length /width /height

maximum weight:

packaging (pcs):

pallet height:

stackable:

FRIS887

775 x 775 x 745

100

26

~ 1910

✓



earthy toupe  
410C



burnt brick  
7600C



pine green  
2411U

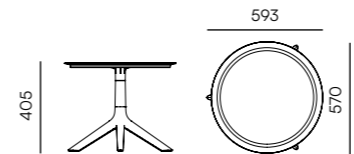

white  
S449



agate gray  
423U



structure effect

### Rimo

Side table

symbol:

dimensions (mm): length /width /height

maximum weight:

packaging (pcs):

pallet height:

stackable:

FRIS64

593 x 570 x 405

50

30

~ 1950

✓



earthy toupe  
410C



burnt brick  
7600C



pine green  
2411U

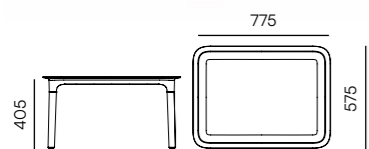

white  
S449



agate gray  
423U



structure effect

### Rimo

Coffee table

symbol:

dimensions (mm): length /width /height

maximum weight:

packaging (pcs):

pallet height:

stackable:

FRIS864

775 x 575 x 405

100

36

~ 1915

✓



earthy toupe  
410C



burnt brick  
7600C



pine green  
2411U

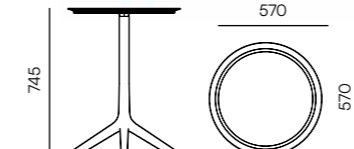

white  
S449



agate gray  
423U



structure effect

### Rimo

High side table

symbol:

dimensions (mm): length /width /height

maximum weight:

packaging (pcs):

pallet height:

stackable:

FRIS67

570 x 570 x 745

50

30

~ 1950

✓

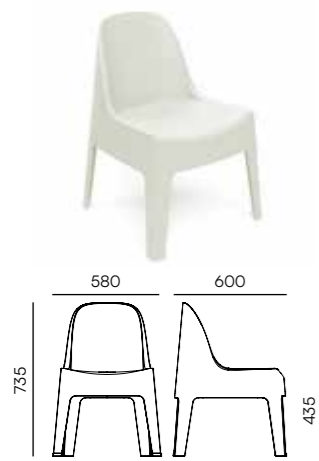

## Milane

Chair

symbol:	dimensions (mm): length /width /height	maximum weight:	packaging (pcs):	pallet height:	stackable:
FMIK667	580 x 600 x 735	110	28	~ 1950	✓

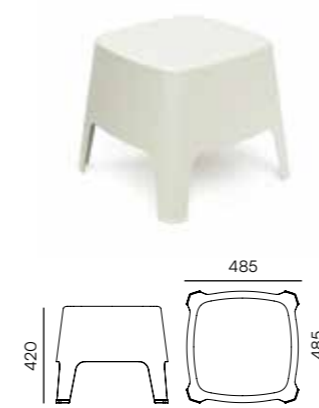

## Milane

Side table & stool

symbol:	dimensions (mm): length /width /height	maximum weight:	packaging (pcs):	pallet height:	stackable:
FMIS554	485 x 485 x 420	110	64	~ 1900	✓

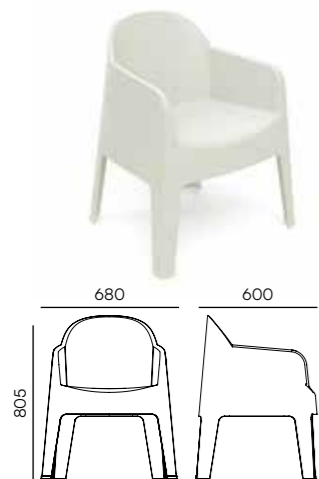

## Milane

Chair with armrests

symbol:	dimensions (mm): length /width /height	maximum weight:	packaging (pcs):	pallet height:	stackable:
FMIK768	680 x 600 x 805	110	28	~ 1950	✓

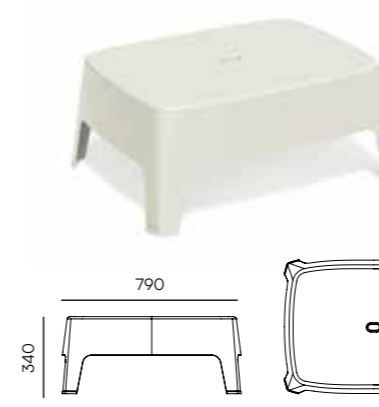

## Milane

Coffee table

symbol:	dimensions (mm): length /width /height	maximum weight:	packaging (pcs):	pallet height:	stackable:
FMIS863	790 x 590 x 340	-	-	~ -	✓



## Milane

Armchair

symbol:	dimensions (mm): length /width /height	maximum weight:	packaging (pcs):	pallet height:	stackable:
FMIK777	745 x 730 x 735	110	18	~ 1830	✓

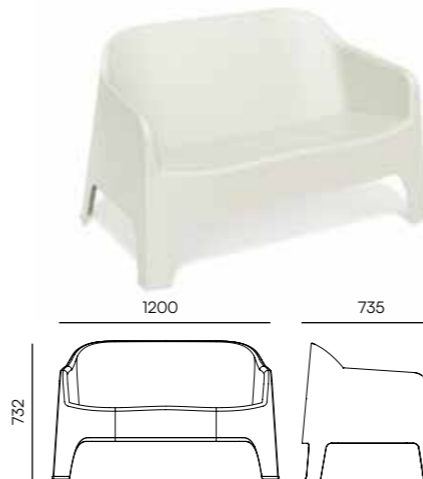

## Milane

Sofa

symbol:	dimensions (mm): length /width /height	maximum weight:	packaging (pcs):	pallet height:	stackable:
FMIK1277	1200 x 735 x 732	220	-	~ -	✓





senza  
7535C



verde  
4193C



light gray  
443U



carbon  
446U

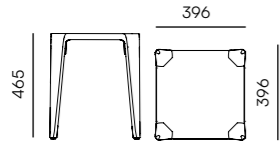

### Lottie

Side table & stool

symbol:	dimensions (mm): length /width /height	maximum weight:	packaging (pcs):	pallet height:	stackable:
FLOS445	396 x 396 x 465	110	90	~ 1900	✓



senza  
7535C



earthy toupe  
410C



verde  
4193C



light gray  
443U



carbon  
446U

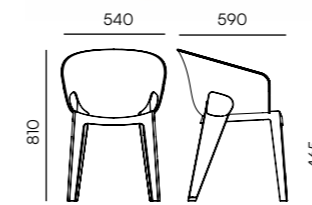

### Premo five

Chair with armrests

symbol:	dimensions (mm): length /width /height	maximum weight:	packaging (pcs):	pallet height:	stackable:
FPRK568	540 x 590 x 810	110	24	~ 1500	✓



senza  
7535C



verde  
4193C



light gray  
443U



carbon  
446U

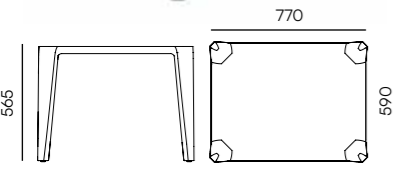

### Lottie

Coffee table

symbol:	dimensions (mm): length /width /height	maximum weight:	packaging (pcs):	pallet height:	stackable:
FLOS866	770 x 590 x 565	100	30	~ 1850	✓



senza  
7535C



earthy toupe  
410C



verde  
4193C



light gray  
443U



carbon  
446U

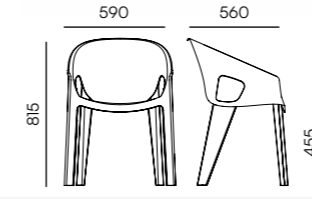

### Premo six

Chair with armrests

symbol:	dimensions (mm): length /width /height	maximum weight:	packaging (pcs):	pallet height:	stackable:
FPRK658	590 x 560 x 815	110	24	~ 1580	✓



senza  
7535C



verde  
4193C



light gray  
443U



carbon  
446U

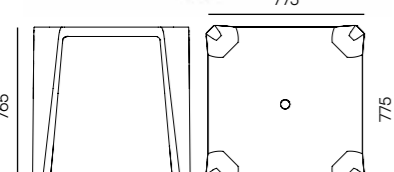

### Lottie

Dining table

symbol:	dimensions (mm): length /width /height	maximum weight:	packaging (pcs):	pallet height:	stackable:
FLOS888	775 x 775 x 765	100	12	~ 1900	✓



senza  
7535C



earthy toupe  
410C



verde  
4193C



light gray  
443U



carbon  
446U

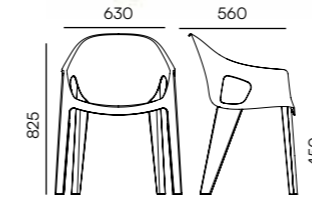

### Premo seven

Chair with armrests

symbol:	dimensions (mm): length /width /height	maximum weight:	packaging (pcs):	pallet height:	stackable:
FPRK758	630 x 560 x 825	110	20	~ 1480	✓

over 90 countries worldwide

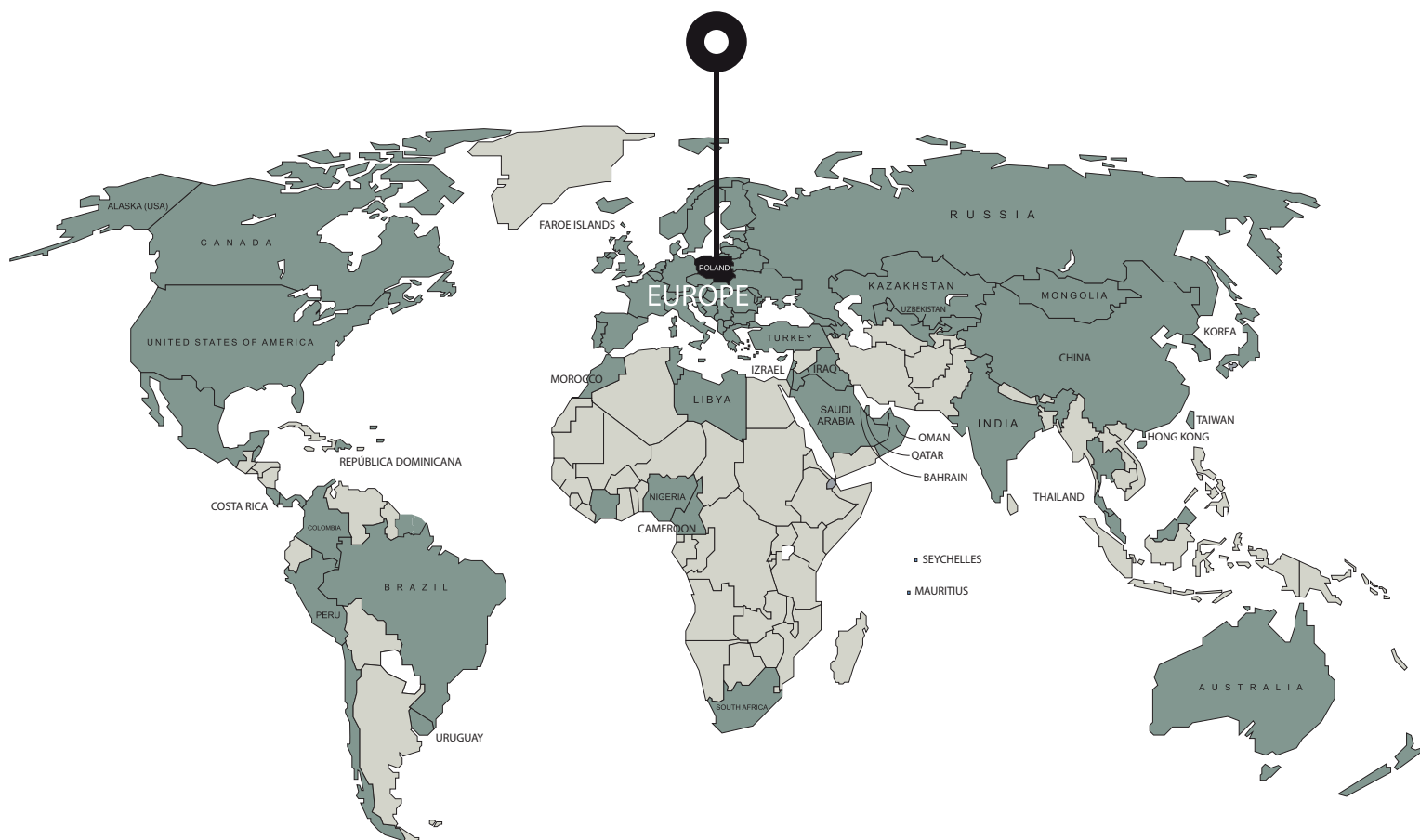

Constantly launching an innovative, diversified and high quality products and being a reliable partner, we managed to succeed on the market in different parts of the world.

Currently our products are successfully distributed to more than 90 countries worldwide and the number of satisfied customers is increasing each year!

## Contact us

### Poland

#### Headquarter, Production & Warehouse

Prosperplast 1 Sp. z o. o.  
Wilkowska 968  
43-378 Rybarzowice  
Poland

tel. +48 33 817 70 03  
fax +48 33 817 60 81

biuro@prosperplast.pl  
office@prosperplast.pl  
www.prosperplast.pl

### Germany

#### Office

Prosperplast Deutschland GmbH  
Hopfenstraße 22a  
85283 Wolnzach  
Germany

tel. +49 8442 9628499  
fax +49 8442 9680853

kontakt@prosperplast.de  
www.prosperplast.de

### Czech Republic

#### Office & Warehouse

Prosperplast s.r.o.  
CTPark Ostrava Hrušov  
Bohumínská 710/198  
711 00 Slezská Ostrava - Hrušov  
Czech Republic

tel. +420 553 034 443  
mob +420 605 499 544

info@prosperplast.cz  
www.prosperplast.cz

### Hungary

#### Office

Prosperplast Kft.  
Tátra u. 5/a, alagsor 2.  
1136-H Budapest,  
Hungary

tel. +36 30 4095 120  
mob +36 30 4095 710

office@prosperplast.hu  
www.prosperplast.hu

Wszystkie prawa zastrzeżone przez Prosperplast 1 Spółka z o.o., a zawartość nie może być powielana, pobierana, rozpowszechniana, publikowana lub przekazywana w jakiegokolwiek formie i w jakikolwiek sposób, bez uprzedniej pisemnej zgody Prosperplast 1 Spółka z o.o.  
Niniejszy katalog nie stanowi oferty w rozumieniu obowiązujących przepisów. Za błędy w druku nie odpowiadamy.

All rights are reserved by Prosperplast 1 Spółka z o. o. and content may not be reproduced, downloaded, disseminated, published, or transferred in any form or by any means, except with the prior written permission of Prosperplast 1 Spółka z o.o.

This catalogue does not constitute an offer within the meaning of applicable rules. We are not responsible for printing errors.



# FERNE

ferne.pl

Prosperplast 1 Sp. z o.o.  
Wilkowska 968  
43-378 Rybarzowice  
Poland